

CVD Coated Grades for Cast Iron Turning

Environmentally Friendly Product

MC5100 Series

Item
Expansion

The ideal grades for a wide range of applications from high speed through to interrupted turning.

MC5105
MC5115
MC5125  **LK**
MK
RK

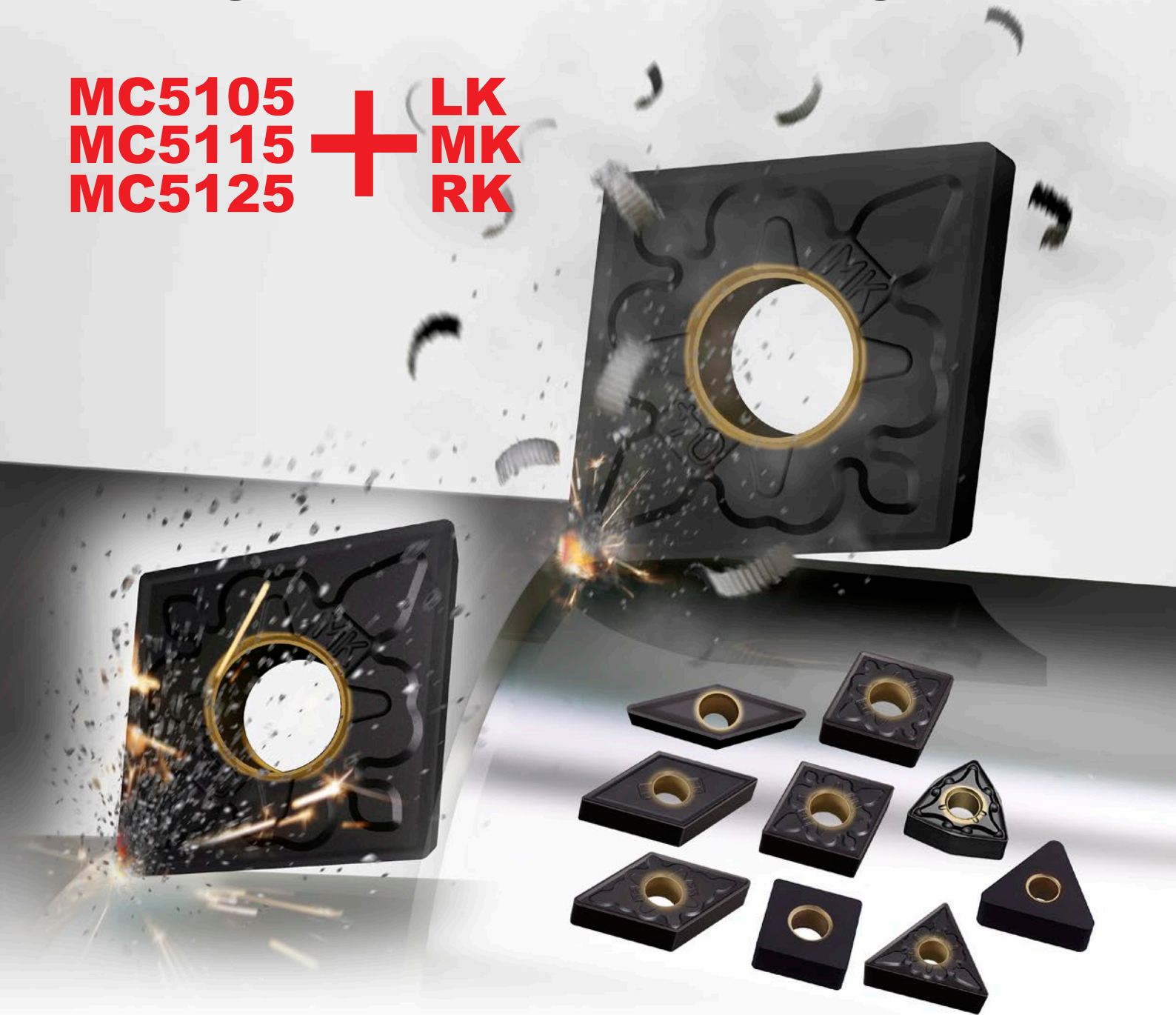



Please refer to the last page for more information on certified environmentally friendly products.

CVD Coated Grades for Cast Iron Turning

MC5100 Series

A choice of different grades ideally suited to all types of cast iron machining.

The process of casting iron enables complex geometries to be formed in the component that is produced. Different types of cast irons produce different chips when machined and can cause various types of damage to an insert. The complex shapes produced in castings also creates challenges when machining and can vary from continuous to interrupted cutting. In response to these challenges, Mitsubishi Materials has created a series of grades that are able to successfully machine all types of cast iron materials and component geometries.

Chip morphology of cast iron

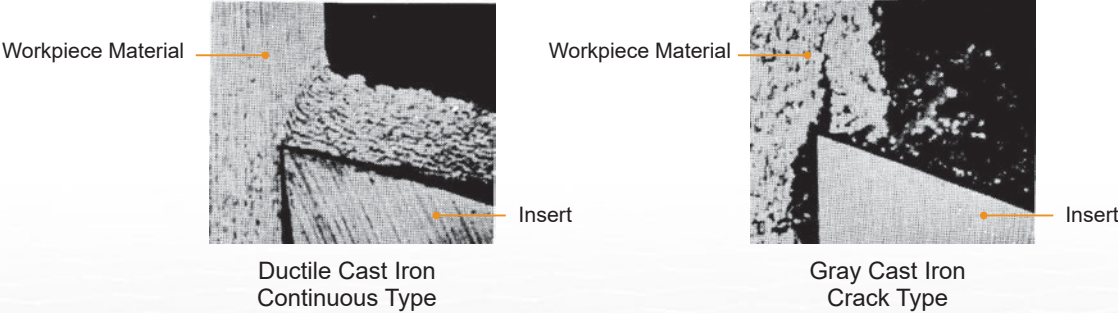

Features

"Super" Nano Texture Technology

The standard Nano Texture Technology has been improved and developed to be an industry leading standard for crystal growth of Al_2O_3 coatings. This Super Nano Texture Technology increases tool life and wear resistance due to the fine, dense crystal growth process.

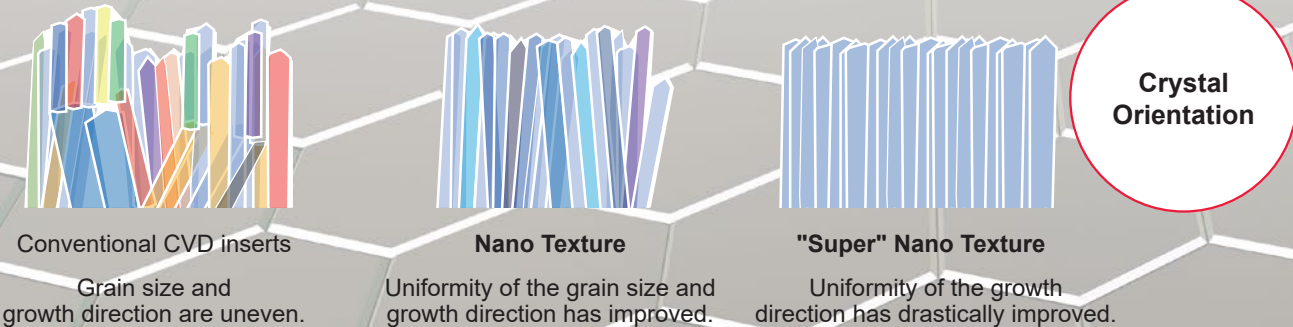
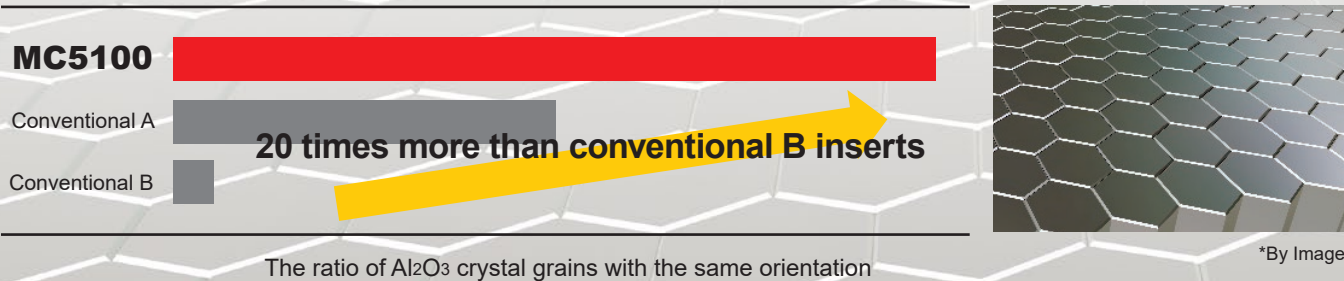

For high speed cutting of gray cast iron

MC5105

Provides outstanding wear resistance when turning gray cast iron at up to 1000 m/min cutting speeds.



First recommended grade for ductile cast iron

MC5115

Prevents abnormal cutting edge damage and displays excellent wear and fracture resistance when machining ductile cast iron.

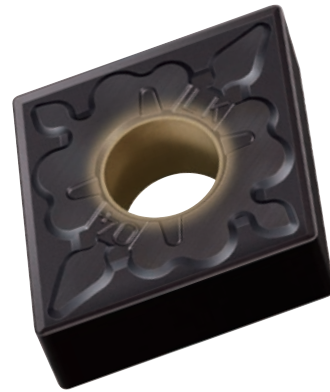

For heavy interrupted cutting of ductile cast iron

MC5125

Demonstrates excellent fracture resistance that can withstand heavy interrupted cutting of high strength ductile cast iron.

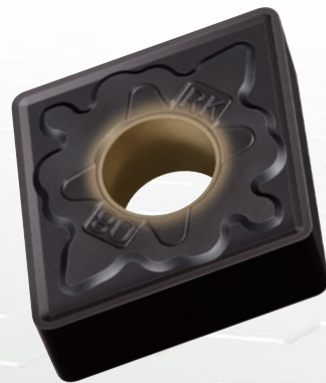

From the Developers

Since gray cast iron tends to be machined at high speeds (500-1000 m/min), it is important to make the Al_2O_3 film coating as strong as possible in order to ensure wear resistance. The focus was on the formation of crystals and the improvement of the intermediate layer of the coating. The coating has also been adjusted to provide excellent intermittent performance despite using a harder carbide substrate compared to conventional products.

Ductile cast iron is machined at relative low speeds (100-300 m/min) and TiCN has a higher hardness. As for the intermittent cutting performance, it was difficult to identify the cause of the edge chipping, but the investigation results revealed that the peeling of the coating was the cause of chipping so a stronger adhesion layer was introduced.

The MC5100 series has been expanded to include grades that are optimal for each type of cast iron turning. These grades will become an indispensable tool for customers that machine cast iron materials.

Tough and Sub Grip Layers for Ductile Cast Iron Grades

The extra strength of the adhesion between the coating layers (1.3 times stronger) suppresses peeling during machining of ductile cast iron.

Adhesion is
1.3 Times*
Greater!

*Compared with a conventional Mitsubishi product.



MC5115

TOUGH-Grip

The interface between the layers is controlled at the nano level, allowing the TOUGH-Grip layer extremely high levels of adhesion to prevent delamination.

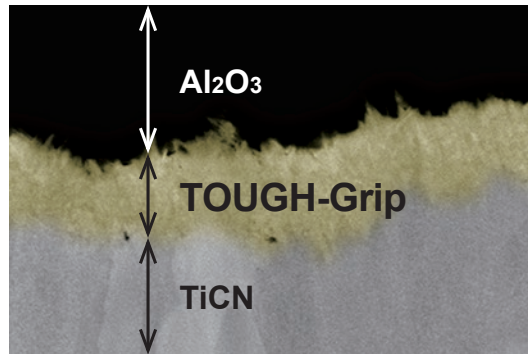

SUB-Grip

By increasing the degree of adhesion between the carbide substrate and the coating layer, a coating layer has been developed that is resistant to peeling even during strong intermittent machining.

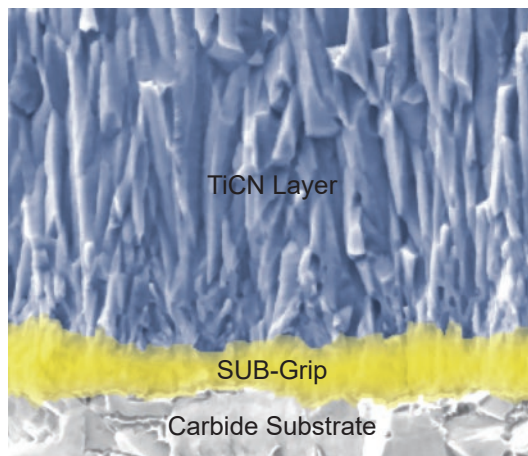

By Image

For high speed cutting of gray cast iron

MC5105

Harder and With Outstanding Wear Resistance

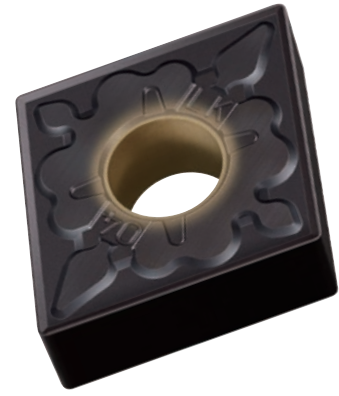

A thick top coating layer

Intermediate layer suitable for high speed cutting

Adhesion Strength Evaluation*

*Adhesion strength measurement is obtained from a scratch test that records the force needed to peel the coating layers.

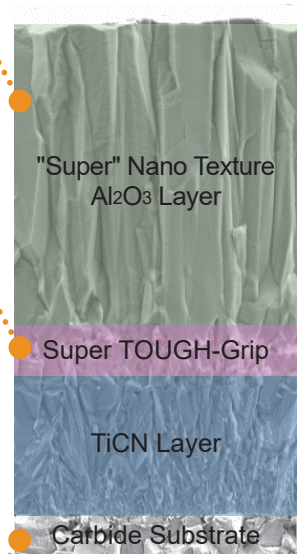
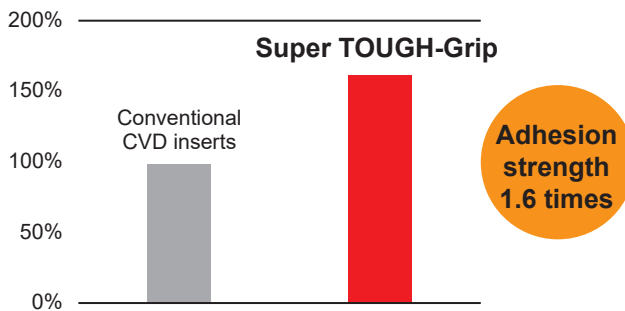

The substrate adopts a high hardness carbide material

Wear resistance comparison when machining of FC300 at cutting speeds of 1000 m/min

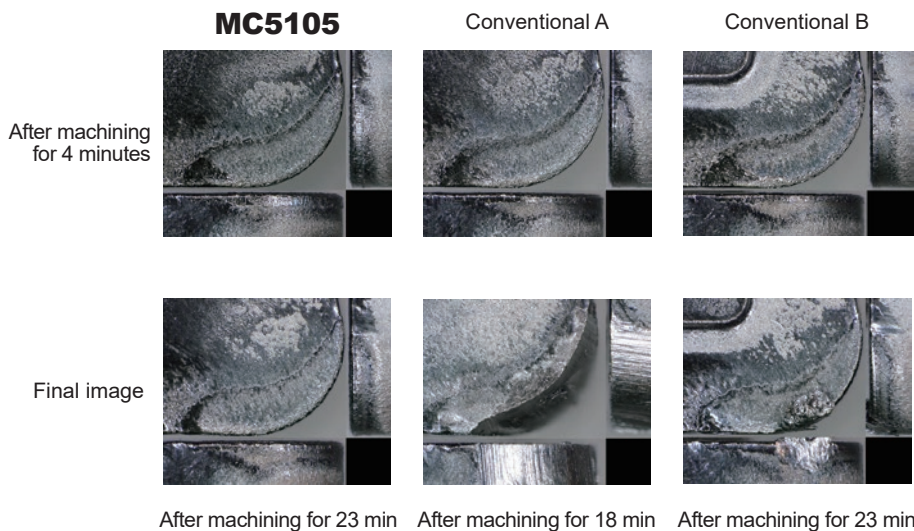

<Cutting Conditions>
 Workpiece Material : JIS FC300
 Inserts : CNMA120412
 Cutting Speed : vc = 1000 m/min
 Feed per Rev. : f = 0.3 mm/rev
 Depth of Cut : ap = 2.0 mm
 Cutting Mode : Dry Cutting

First recommended grade
for ductile cast iron

MC5115

Excellent Durability and
Resistance to Impacts

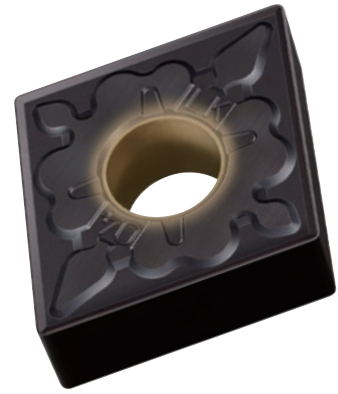

Al₂O₃ layer with excellent wear resistance

Intermediate layer with microstructure suitable
for ductile cast iron

Thick TiCN layer suitable for coping with the
hardness of ductile cast iron

New adhesion layer with an enhanced resistance
to peeling

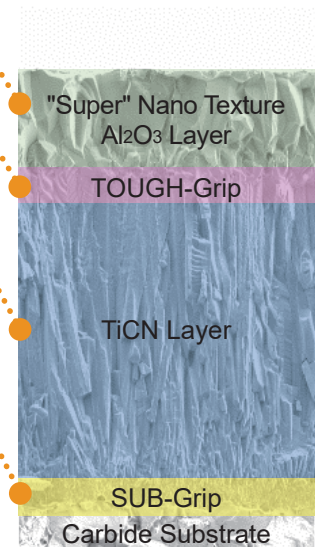

Comparison of wear resistance during continuous cutting of FCD700

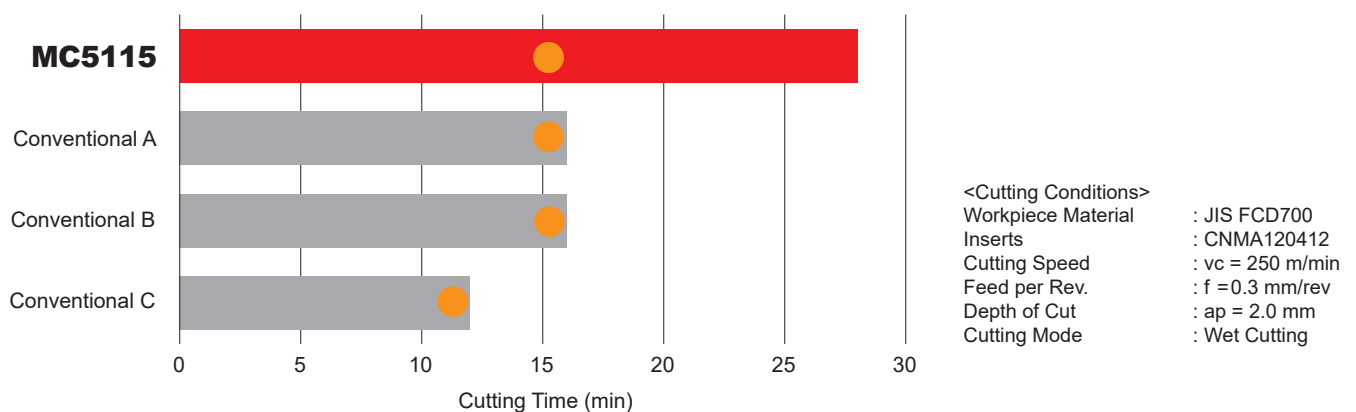

After machining for 16 minutes



MC5115

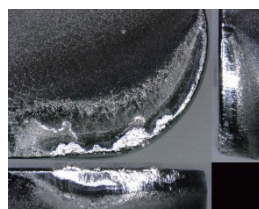

Conventional A

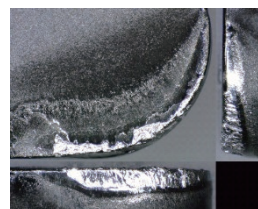

Conventional B

After machining for 12 minutes



Conventional C

For heavy interrupted cutting of ductile cast iron

MC5125

Excellent Stability and Fracture Resistance

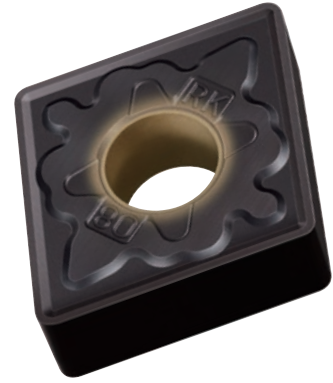

Al₂O₃ layer with excellent wear resistance

Intermediate layer with microstructure suitable for ductile cast iron

TiCN layer for hardness for heavy interrupted cutting

New adhesion layer with an enhanced resistance to peeling

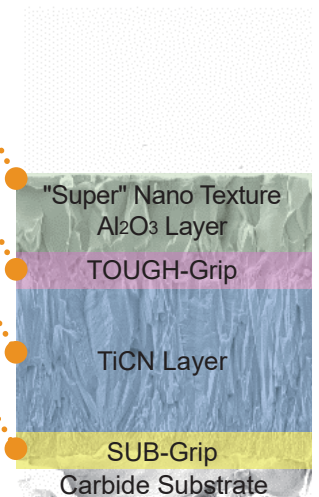

Comparison of fracture resistance after 10 passes of interrupted cutting of FCD700

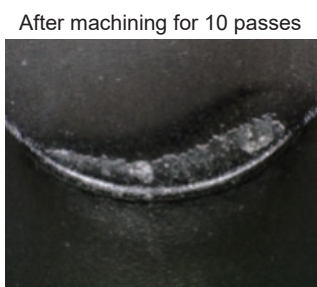
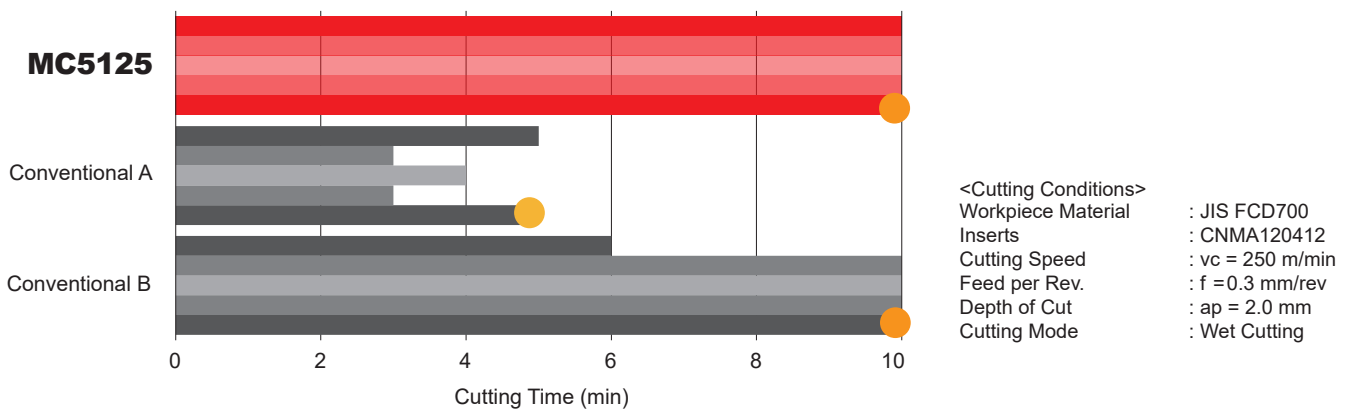

MC5125



Conventional A

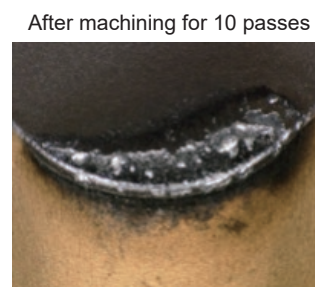

Conventional B

Way to Select MC5100 Series

Gray Cast Iron

MC5105 is the first recommendation for high speed machining of gray cast iron.

Select a suitable chip breaker to optimise tool life and reduce wear.

MC5115 is also capable of reliable machining at speeds of 100-300 m/min and for unstable cutting conditions.

High Speed Cutting 200–1000m/min

MC5105

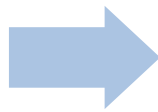

In case of fracture

Change to a chip breaker with a stronger cutting edge geometry

Cutting Speed 100–300m/min

MC5115

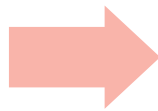

In case of wear

Change to a chip breaker with a sharper cutting edge geometry

Refer to page 9 for the chip breaker selection.

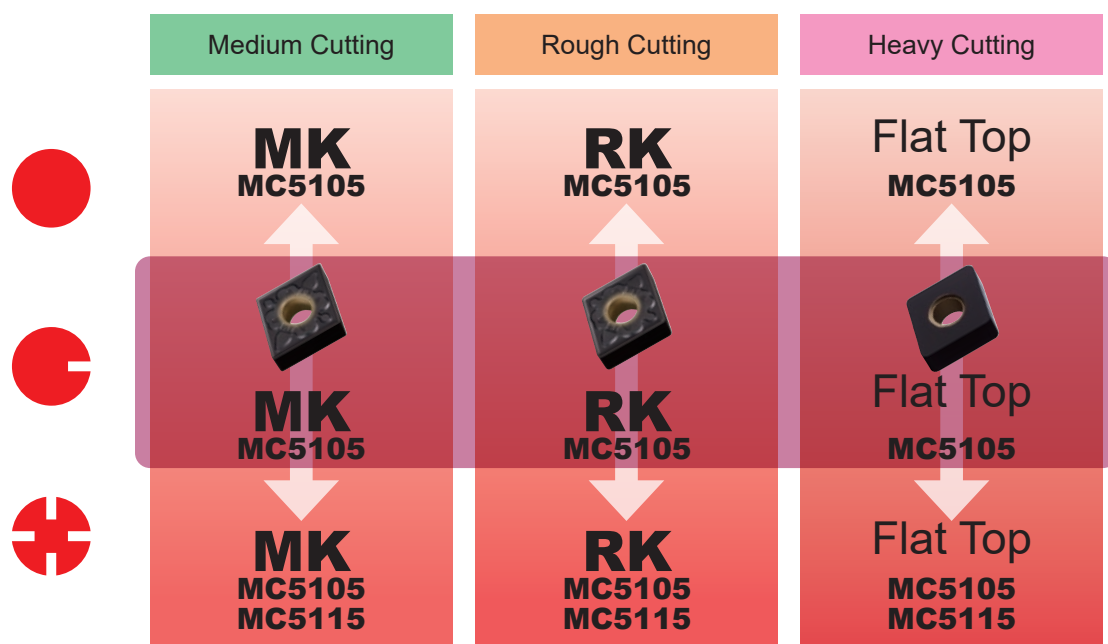

Cutting Conditions : ● : Stable Cutting ◐ : General Cutting ⊕ : Unstable Cutting

Ductile Cast Iron

MC5115 is the first recommendation for ductile cast iron, including high strength ductile cast iron.

In order to prevent breakage and wear, select a suitable chip breaker.

MC5125 is also effective for heavy, interrupted and unstable cutting conditions.

First Recommendation

MC5115

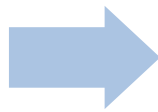

Change to a chip breaker with a stronger cutting edge geometry

In case of fracture



In case of fracture



In case of wear

Heavy, Interrupted Cutting

MC5125

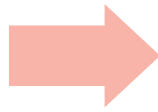

Change to a chip breaker with a sharper cutting edge geometry

In case of wear

Refer to page 9 for the chip breaker selection.

	Light Cutting	Medium Cutting	Rough Cutting	Heavy Cutting
●	LK MC5115	MK MC5115	RK MC5115	Flat Top MC5115
◐	LK MC5115	MK MC5115	RK MC5115	Flat Top MC5115
⊕	LK MC5125	MK MC5125	RK MC5125	Flat Top MC5125

Cutting Conditions : ● : Stable Cutting ◐ : General Cutting ⊕ : Unstable Cutting

Chip breaker system for cast iron turning

The entire range of new chip breakers has been designed by taking advantage of the properties of the new grades. Each breaker has the optimum suitability for each respective application.





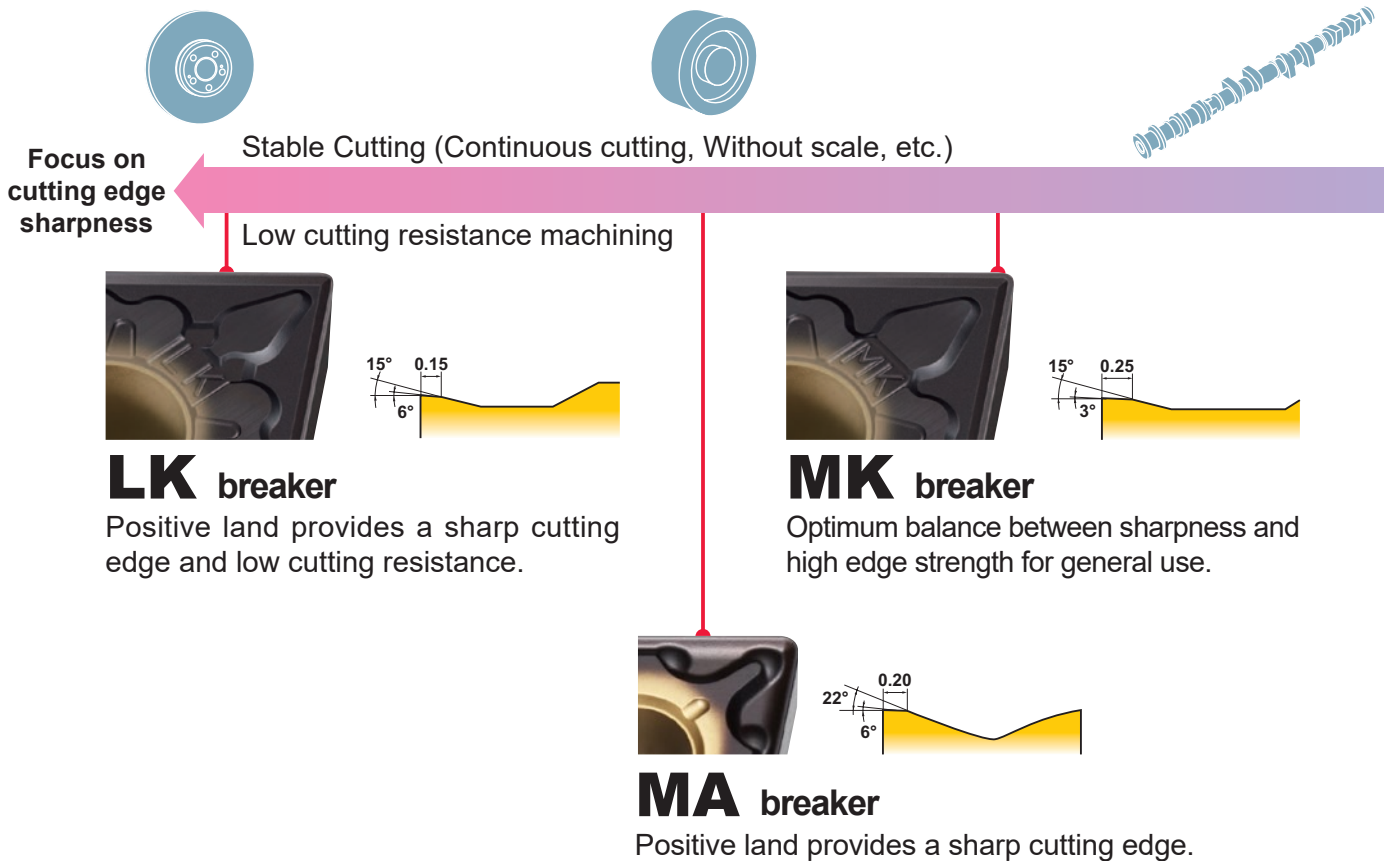

Negative Inserts

LK/MK/RK/Flat Top, GK/MA breaker

Select a chip breaker according to the machining conditions.



Chip Breaker Selection

Cutting Area	Chip Breaker		Features
Light Cutting	SH		Can be used low depth of cut and high feed rates. The curved edge allows smooth chip discharge.
	SW		In comparison to conventional chip breakers, the surface finish is maintained even if the feed per revolution is doubled. A wide chip pocket prevents chip jamming.
Medium Cutting	MP		Suitable for medium to light cutting. Chip breaker geometry appropriate for copying and back turning. Cutting edge geometry for an optimum balance of sharpness and fracture resistance.
	MW		The wiper allows up to double times higher feed. A wide chip pocket prevents chip jamming.
	MH		Flat land offers high edge strength. Good chip control with suitable chip pocket.
Rough Cutting	GH		For interrupted cutting and removing scale. A combination of wide land and a large chip pocket allows high feed rates.

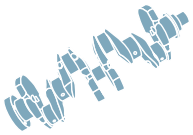

Unstable Cutting (Interrupted cutting, With scale, etc.)

Focus on cutting edge strength

General to Heavy cutting

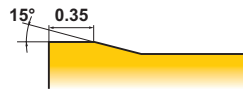

RK breaker

Extra wide land provides a stable cutting edge for interrupted machining and removal of scale.



Flat Top

Flat top focusing on high edge strength.

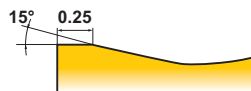

GK breaker

Versatile standard breaker. Flat land maintains a stable cutting edge.

Application map for cast iron

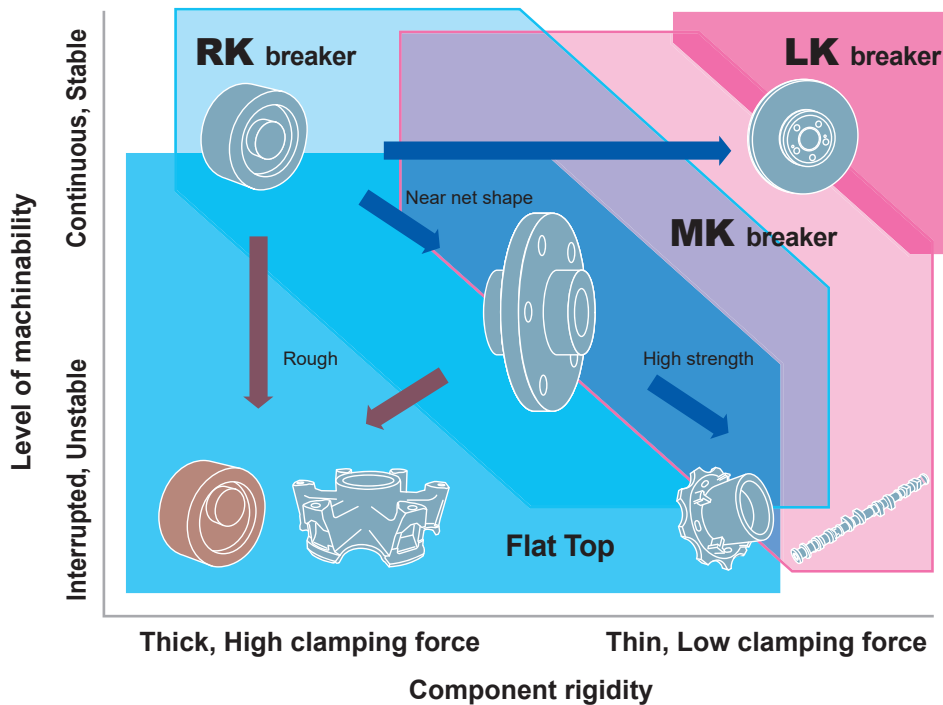

MC5100 Series

Negative Inserts (With hole)

M Class

CNMG
CNMA

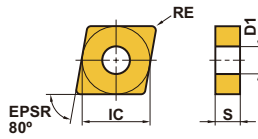

Light Cutting LK	Light Cutting SH	Light Cutting SW	Medium Cutting MP	Medium Cutting MK	Medium Cutting GK
		 (Wiper)			
Medium Cutting MA	Medium Cutting MW	Medium Cutting MH	Rough Cutting RK	Rough Cutting GH	Strong Cutting Edge Flat Top
	 (Wiper)				

(mm)

Order Number	Cutting Area	Cutting Area			IC	S	RE	D1
		MC5105	MC5115	MC5125				
CNMG120404-LK	L	●	●	●	12.7	4.76	0.4	5.16
CNMG120408-LK	L	●	●	●	12.7	4.76	0.8	5.16
CNMG120412-LK	L	●	●	●	12.7	4.76	1.2	5.16
NEW CNMG120404-SH	L	●	●	●	12.7	4.76	0.4	5.16
NEW CNMG120408-SH	L	●	●	●	12.7	4.76	0.8	5.16
NEW CNMG120404-SW	L	●	●	●	12.7	4.76	0.4	5.16
NEW CNMG120408-SW	L	●	●	●	12.7	4.76	0.8	5.16
NEW CNMG120404-MP	M	●	●	●	12.7	4.76	0.4	5.16
NEW CNMG120408-MP	M	●	●	●	12.7	4.76	0.8	5.16
NEW CNMG120412-MP	M	●	●	●	12.7	4.76	1.2	5.16
NEW CNMG120416-MP	M	●	●	●	12.7	4.76	1.6	5.16
NEW CNMG160608-MP	M	●	●	●	15.875	6.35	0.8	6.35
NEW CNMG160612-MP	M	●	●	●	15.875	6.35	1.2	6.35
NEW CNMG160616-MP	M	●	●	●	15.875	6.35	1.6	6.35
CNMG120404-MK	M	●	●	●	12.7	4.76	0.4	5.16
CNMG120408-MK	M	●	●	●	12.7	4.76	0.8	5.16
CNMG120412-MK	M	●	●	●	12.7	4.76	1.2	5.16
CNMG120416-MK	M	●	●	●	12.7	4.76	1.6	5.16
CNMG160608-MK	M	●	●	●	15.875	6.35	0.8	6.35
CNMG160612-MK	M	●	●	●	15.875	6.35	1.2	6.35
CNMG160616-MK	M	●	●	●	15.875	6.35	1.6	6.35
CNMG190612-MK	M	●	●	●	19.05	6.35	1.2	7.93
CNMG190616-MK	M	●	●	●	19.05	6.35	1.6	7.93
CNMG120404-GK	M	●	●	●	12.7	4.76	0.4	5.16
CNMG120408-GK	M	●	●	●	12.7	4.76	0.8	5.16
CNMG120412-GK	M	●	●	●	12.7	4.76	1.2	5.16
CNMG120416-GK	M	●	●	●	12.7	4.76	1.6	5.16
CNMG160612-GK	M	●	●	●	15.875	6.35	1.2	6.35
CNMG160616-GK	M	●	●	●	15.875	6.35	1.6	6.35
NEW CNMG190612-GK	M	●	●	●	19.05	6.35	1.2	7.93
NEW CNMG190616-GK	M	●	●	●	19.05	6.35	1.6	7.93
CNMG120404-MA	M	●	●	●	12.7	4.76	0.4	5.16
CNMG120408-MA	M	●	●	●	12.7	4.76	0.8	5.16
CNMG120412-MA	M	●	●	●	12.7	4.76	1.2	5.16
CNMG120416-MA	M	●	●	●	12.7	4.76	1.6	5.16
CNMG160608-MA	M	●	●	●	15.875	6.35	0.8	6.35
CNMG160612-MA	M	●	●	●	15.875	6.35	1.2	6.35
CNMG160616-MA	M	●	●	●	15.875	6.35	1.6	6.35
NEW CNMG190612-MA	M	●	●	●	19.05	6.35	1.2	7.93
NEW CNMG190616-MA	M	●	●	●	19.05	6.35	1.6	7.93

Order Number	Cutting Area	Cutting Area			IC	S	RE	D1
		MC5105	MC5115	MC5125				
NEW CNMG120408-MW	M	●	●	●	12.7	4.76	0.8	5.16
NEW CNMG120412-MW	M	●	●	●	12.7	4.76	1.2	5.16
NEW CNMG120408-MH	M	●	●	●	12.7	4.76	0.8	5.16
NEW CNMG120412-MH	M	●	●	●	12.7	4.76	1.2	5.16
NEW CNMG120416-MH	M	●	●	●	12.7	4.76	1.6	5.16
NEW CNMG160608-MH	M	●	●	●	15.875	6.35	0.8	6.35
NEW CNMG160612-MH	M	●	●	●	15.875	6.35	1.2	6.35
NEW CNMG160616-MH	M	●	●	●	15.875	6.35	1.6	6.35
NEW CNMG190612-MH	M	●	●	●	19.05	6.35	1.2	7.93
CNMG120408-RK	R	●	●	●	12.7	4.76	0.8	5.16
CNMG120412-RK	R	●	●	●	12.7	4.76	1.2	5.16
CNMG120416-RK	R	●	●	●	12.7	4.76	1.6	5.16
CNMG160608-RK	R	●	●	●	15.875	6.35	0.8	6.35
CNMG160612-RK	R	●	●	●	15.875	6.35	1.2	6.35
CNMG160616-RK	R	●	●	●	15.875	6.35	1.6	6.35
CNMG190612-RK	R	●	●	●	19.05	6.35	1.2	7.93
CNMG190616-RK	R	●	●	●	19.05	6.35	1.6	7.93
NEW CNMG120408-GH	R	●	●	●	12.7	4.76	0.8	5.16
NEW CNMG120412-GH	R	●	●	●	12.7	4.76	1.2	5.16
NEW CNMG120416-GH	R	●	●	●	12.7	4.76	1.6	5.16
NEW CNMG160612-GH	R	●	●	●	15.875	6.35	1.2	6.35
NEW CNMG160616-GH	R	●	●	●	15.875	6.35	1.6	6.35
NEW CNMG190612-GH	R	●	●	●	19.05	6.35	1.2	7.93
NEW CNMG190616-GH	R	●	●	●	19.05	6.35	1.6	7.93
CNMA120404	-	●	●	●	12.7	4.76	0.4	5.16
CNMA120408	-	●	●	●	12.7	4.76	0.8	5.16
CNMA120412	-	●	●	●	12.7	4.76	1.2	5.16
CNMA120416	-	●	●	●	12.7	4.76	1.6	5.16
CNMA160612	-	●	●	●	15.875	6.35	1.2	6.35
CNMA160616	-	●	●	●	15.875	6.35	1.6	6.35
CNMA190612	-	●	●	●	19.05	6.35	1.2	7.93
CNMA190616	-	●	●	●	19.05	6.35	1.6	7.93
CNMA190624	-	●	●	●	19.05	6.35	2.4	7.93

● = NEW

● : Inventory maintained in Japan.
(10 inserts in one case)

Negative Inserts (With hole)

M Class

DNMG
DNMA

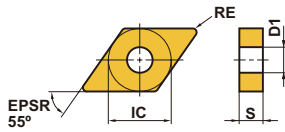

Light Cutting LK	Light Cutting SH	Medium Cutting MP	Medium Cutting MK	Medium Cutting GK	Medium Cutting MA
Medium Cutting MH	Medium Cutting MW (Wiper)	Rough Cutting RK	Rough Cutting GH	Strong Cutting Edge Flat Top	

(mm)

Order Number	Cutting Area	Cutting Area			IC	S	RE	D1
		MC5105	MC5115	MC5125				
DNMG110408-LK	L	●	●	●	9.525	4.76	0.8	3.81
DNMG150404-LK	L	●	●	●	12.7	4.76	0.4	5.16
DNMG150408-LK	L	●	●	●	12.7	4.76	0.8	5.16
DNMG150412-LK	L	●	●	●	12.7	4.76	1.2	5.16
DNMG150604-LK	L	●	●	●	12.7	6.35	0.4	5.16
DNMG150608-LK	L	●	●	●	12.7	6.35	0.8	5.16
DNMG150612-LK	L	●	●	●	12.7	6.35	1.2	5.16
NEW DNMG150404-SH	L	●	●	●	12.7	4.76	0.4	5.16
NEW DNMG150408-SH	L	●	●	●	12.7	4.76	0.8	5.16
NEW DNMG150412-SH	L	●	●	●	12.7	4.76	1.2	5.16
NEW DNMG150608-SH	L	●	●	●	12.7	6.35	0.8	5.16
NEW DNMG150612-SH	L	●	●	●	12.7	6.35	1.2	5.16
NEW DNMG150404-MP	M	●	●	●	12.7	4.76	0.4	5.16
NEW DNMG150408-MP	M	●	●	●	12.7	4.76	0.8	5.16
NEW DNMG150412-MP	M	●	●	●	12.7	4.76	1.2	5.16
NEW DNMG150416-MP	M	●	●	●	12.7	4.76	1.6	5.16
NEW DNMG150604-MP	M	●	●	●	12.7	6.35	0.4	5.16
NEW DNMG150608-MP	M	●	●	●	12.7	6.35	0.8	5.16
NEW DNMG150612-MP	M	●	●	●	12.7	6.35	1.2	5.16
NEW DNMG150616-MP	M	●	●	●	12.7	6.35	1.6	5.16
DNMG110408-MK	M	●	●	●	9.525	4.76	0.8	3.81
DNMG150404-MK	M	●	●	●	12.7	4.76	0.4	5.16
DNMG150408-MK	M	●	●	●	12.7	4.76	0.8	5.16
DNMG150412-MK	M	●	●	●	12.7	4.76	1.2	5.16
DNMG150604-MK	M	●	●	●	12.7	6.35	0.4	5.16
DNMG150608-MK	M	●	●	●	12.7	6.35	0.8	5.16
DNMG150612-MK	M	●	●	●	12.7	6.35	1.2	5.16
NEW DNMG110408-GK	M	●	●	●	9.525	4.76	0.8	3.81
DNMG150404-GK	M	●	●	●	12.7	4.76	0.4	5.16
DNMG150408-GK	M	●	●	●	12.7	4.76	0.8	5.16
DNMG150412-GK	M	●	●	●	12.7	4.76	1.2	5.16
DNMG150604-GK	M	●	●	●	12.7	6.35	0.4	5.16
DNMG150608-GK	M	●	●	●	12.7	6.35	0.8	5.16
DNMG150612-GK	M	●	●	●	12.7	6.35	1.2	5.16
DNMG150404-MA	M	●	●	●	12.7	4.76	0.4	5.16
DNMG150408-MA	M	●	●	●	12.7	4.76	0.8	5.16
DNMG150412-MA	M	●	●	●	12.7	4.76	1.2	5.16
DNMG150604-MA	M	●	●	●	12.7	6.35	0.4	5.16
DNMG150608-MA	M	●	●	●	12.7	6.35	0.8	5.16
DNMG150612-MA	M	●	●	●	12.7	6.35	1.2	5.16

Order Number	Cutting Area	Cutting Area			IC	S	RE	D1
		MC5105	MC5115	MC5125				
NEW DNMG150408-MH	M	●	●	●	12.7	4.76	0.8	5.16
NEW DNMG150412-MH	M	●	●	●	12.7	4.76	1.2	5.16
NEW DNMG150604-MH	M	●	●	●	12.7	4.76	0.4	5.16
NEW DNMG150608-MH	M	●	●	●	12.7	6.35	0.8	5.16
NEW DNMG150612-MH	M	●	●	●	12.7	6.35	1.2	5.16
NEW DNMX150408-MW	M	●	●	●	12.7	4.76	0.8	5.16
NEW DNMX150412-MW	M	●	●	●	12.7	4.76	1.2	5.16
NEW DNMX150608-MW	M	●	●	●	12.7	6.35	0.8	5.16
NEW DNMX150612-MW	M	●	●	●	12.7	6.35	1.2	5.16
DNMG150408-RK	R	●	●	●	12.7	4.76	0.8	5.16
DNMG150412-RK	R	●	●	●	12.7	4.76	1.2	5.16
DNMG150608-RK	R	●	●	●	12.7	6.35	0.8	5.16
DNMG150612-RK	R	●	●	●	12.7	6.35	1.2	5.16
NEW DNMG150408-GH	R	●	●	●	12.7	4.76	0.8	5.16
NEW DNMG150412-GH	R	●	●	●	12.7	4.76	1.2	5.16
NEW DNMG150608-GH	R	●	●	●	12.7	6.35	0.8	5.16
NEW DNMG150612-GH	R	●	●	●	12.7	6.35	1.2	5.16
DNMA150404	-	●	●	●	12.7	4.76	0.4	5.16
DNMA150408	-	●	●	●	12.7	4.76	0.8	5.16
DNMA150412	-	●	●	●	12.7	4.76	1.2	5.16
DNMA150604	-	●	●	●	12.7	6.35	0.4	5.16
DNMA150608	-	●	●	●	12.7	6.35	0.8	5.16
DNMA150612	-	●	●	●	12.7	6.35	1.2	5.16

● = NEW

MC5100 Series

Negative Inserts (With hole)

M Class

SNMG
SNMA

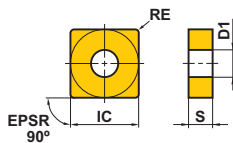

Light Cutting	Light Cutting	Medium Cutting	Medium Cutting	Medium Cutting	Medium Cutting
LK	SH	MP	MK	GK	MA
Medium Cutting	Rough Cutting	Rough Cutting	Strong Cutting Edge		
MH	RK	GH	Flat Top		

(mm)

Order Number	Cutting Area	MC5100 Series			IC	S	RE	D1
		MC5105	MC5115	MC5125				
SNMG120408-LK	L	●	●	●	12.7	4.76	0.8	5.16
SNMG120412-LK	L	●	●	●	12.7	4.76	1.2	5.16
NEW SNMG120404-SH	L		●		12.7	4.76	0.4	5.16
NEW SNMG120408-SH	L		●		12.7	4.76	0.8	5.16
NEW SNMG120412-SH	L		●		12.7	4.76	1.2	5.16
NEW SNMG120404-MP	M		●		12.7	4.76	0.4	5.16
NEW SNMG120408-MP	M		●		12.7	4.76	0.8	5.16
NEW SNMG120412-MP	M		●		12.7	4.76	1.2	5.16
SNMG120408-MK	M	●	●	●	12.7	4.76	0.8	5.16
SNMG120412-MK	M	●	●	●	12.7	4.76	1.2	5.16
SNMG120416-MK	M	●	●	●	12.7	4.76	1.6	5.16
SNMG150612-MK	M	●	●	●	15.875	6.35	1.2	6.35
SNMG150616-MK	M	●	●	●	15.875	6.35	1.6	6.35
SNMG190612-MK	M	●	●	●	19.05	6.35	1.2	7.93
SNMG190616-MK	M	●	●	●	19.05	6.35	1.6	7.93
SNMG120404-GK	M	●	●	●	12.7	4.76	0.4	5.16
SNMG120408-GK	M	●	●	●	12.7	4.76	0.8	5.16
SNMG120412-GK	M	●	●	●	12.7	4.76	1.2	5.16
SNMG120416-GK	M	●	●	●	12.7	4.76	1.6	5.16
SNMG150612-GK	M	●	●	●	15.875	6.35	1.2	6.35
NEW SNMG190612-GK	M	●	●	●	19.05	6.35	1.2	7.93
NEW SNMG190616-GK	M		●	●	19.05	6.35	1.6	7.93
SNMG120404-MA	M	●	●	●	12.7	4.76	0.4	5.16
SNMG120408-MA	M	●	●	●	12.7	4.76	0.8	5.16
SNMG120412-MA	M	●	●	●	12.7	4.76	1.2	5.16
SNMG120416-MA	M	●	●	●	12.7	4.76	1.6	5.16
SNMG150612-MA	M		●	●	15.875	6.35	1.2	6.35
NEW SNMG190612-MA	M		●	●	19.05	6.35	1.2	7.93
NEW SNMG120408-MH	M		●		12.7	4.76	0.8	5.16
NEW SNMG120412-MH	M		●		12.7	4.76	1.2	5.16
NEW SNMG190612-MH	M		●		19.05	6.35	1.2	7.93

Order Number	Cutting Area	MC5100 Series			IC	S	RE	D1
		MC5105	MC5115	MC5125				
SNMG120408-RK	R	●	●	●	12.7	4.76	0.8	5.16
SNMG120412-RK	R	●	●	●	12.7	4.76	1.2	5.16
SNMG120416-RK	R	●	●	●	12.7	4.76	1.6	5.16
SNMG150612-RK	R	●	●	●	15.875	6.35	1.2	6.35
SNMG150616-RK	R	●	●	●	15.875	6.35	1.6	6.35
SNMG190612-RK	R	●	●	●	19.05	6.35	1.2	7.93
SNMG190616-RK	R	●	●	●	19.05	6.35	1.6	7.93
NEW SNMG120408-GH	R	●	●	●	12.7	4.76	0.8	5.16
NEW SNMG120412-GH	R	●	●	●	12.7	4.76	1.2	5.16
SNMA090308	-	●	●	●	9.525	3.18	0.8	3.81
SNMA120408	-	●	●	●	12.7	4.76	0.8	5.16
SNMA120412	-	●	●	●	12.7	4.76	1.2	5.16
SNMA120416	-	●	●	●	12.7	4.76	1.6	5.16
SNMA150612	-	●	●	●	15.875	6.35	1.2	6.35
SNMA150616	-	●	●	●	15.875	6.35	1.6	6.35
SNMA190612	-	●	●	●	19.05	6.35	1.2	7.93
SNMA190616	-	●	●	●	19.05	6.35	1.6	7.93

● = NEW

Negative Inserts (With hole)

M Class

TNMG
TNMA
TNMX

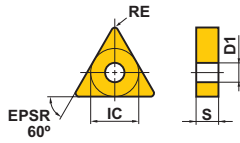

Light Cutting LK	Light Cutting SH	Medium Cutting MP	Medium Cutting MK	Medium Cutting GK	Medium Cutting MA
Medium Cutting MH	Medium Cutting MW (Wiper)	Rough Cutting RK	Rough Cutting GH	Strong Cutting Edge Flat Top	

(mm)

Order Number	Cutting Area	MC5105	MC5115	MC5125	IC	S	RE	D1
TNMG160404-LK	L	●	●	●	9.525	4.76	0.4	3.81
TNMG160408-LK	L	●	●	●	9.525	4.76	0.8	3.81
TNMG160412-LK	L	●	●	●	9.525	4.76	1.2	3.81
TNMG160404-SH	L		●		9.525	4.76	0.4	3.81
TNMG160408-SH	L		●		9.525	4.76	0.8	3.81
NEW TNMG160404-MP	M		●		9.525	4.76	0.4	3.81
NEW TNMG160408-MP	M		●		9.525	4.76	0.8	3.81
NEW TNMG160412-MP	M		●		9.525	4.76	1.2	3.81
NEW TNMG220408-MP	M		●		12.7	4.76	0.8	5.16
NEW TNMG220412-MP	M		●		12.7	4.76	1.2	5.16
TNMG160404-MK	M	●	●	●	9.525	4.76	0.4	3.81
TNMG160408-MK	M	●	●	●	9.525	4.76	0.8	3.81
TNMG160412-MK	M	●	●	●	9.525	4.76	1.2	3.81
TNMG220408-MK	M	●	●	●	12.7	4.76	0.8	5.16
TNMG220412-MK	M	●	●	●	12.7	4.76	1.2	5.16
TNMG220416-MK	M	●	●	●	12.7	4.76	1.6	5.16
TNMG160404-GK	M	●	●	●	9.525	4.76	0.4	3.81
TNMG160408-GK	M	●	●	●	9.525	4.76	0.8	3.81
TNMG160412-GK	M	●	●	●	9.525	4.76	1.2	3.81
TNMG160416-GK	M	●	●	●	9.525	4.76	1.6	3.81
TNMG220408-GK	M	●	●	●	12.7	4.76	0.8	5.16
TNMG220412-GK	M	●	●	●	12.7	4.76	1.2	5.16
TNMG160404-MA	M	●	●	●	9.525	4.76	0.4	3.81
TNMG160408-MA	M	●	●	●	9.525	4.76	0.8	3.81
TNMG160412-MA	M	●	●	●	9.525	4.76	1.2	3.81
TNMG160416-MA	M	●	●	●	9.525	4.76	1.6	3.81
TNMG220408-MA	M	●	●	●	12.7	4.76	0.8	5.16
TNMG220412-MA	M	●	●	●	12.7	4.76	1.2	5.16
TNMG220416-MA	M		●	●	12.7	4.76	1.6	5.16
NEW TNMG160404-MH	M		●		9.525	4.76	0.4	3.81
NEW TNMG160408-MH	M		●		9.525	4.76	0.8	3.81
NEW TNMG160412-MH	M		●		9.525	4.76	1.2	3.81
NEW TNMG220408-MH	M		●		12.7	4.76	0.8	5.16
NEW TNMG220412-MH	M		●		12.7	4.76	1.2	5.16
NEW TNMX160408-MW	M	●	●	●	9.525	4.76	0.8	3.81
NEW TNMX160412-MW	M	●	●	●	9.525	4.76	1.2	3.81
TNMG160408-RK	R	●	●	●	9.525	4.76	0.8	3.81
TNMG160412-RK	R	●	●	●	9.525	4.76	1.2	3.81
TNMG160416-RK	R	●	●	●	9.525	4.76	1.6	3.81
TNMG220408-RK	R	●	●	●	12.7	4.76	0.8	5.16
TNMG220412-RK	R	●	●	●	12.7	4.76	1.2	5.16
TNMG220416-RK	R	●	●	●	12.7	4.76	1.6	5.16
NEW TNMG160408-GH	R	●	●	●	9.525	4.76	0.8	3.81
NEW TNMG160412-GH	R		●	●	9.525	4.76	1.2	3.81
NEW TNMG220408-GH	R		●	●	12.7	4.76	0.8	5.16
NEW TNMG220412-GH	R	●	●	●	12.7	4.76	1.2	5.16
TNMA160404	-	●	●	●	9.525	4.76	0.4	3.81
TNMA160408	-	●	●	●	9.525	4.76	0.8	3.81
TNMA160412	-	●	●	●	9.525	4.76	1.2	3.81
TNMA160416	-	●	●	●	9.525	4.76	1.6	3.81
TNMA160420	-	●	●	●	9.525	4.76	2.0	3.81
TNMA220408	-	●	●	●	12.7	4.76	0.8	5.16
TNMA220412	-	●	●	●	12.7	4.76	1.2	5.16
TNMA220416	-	●	●	●	12.7	4.76	1.6	5.16

● = NEW

MC5100 Series

Negative Inserts (With hole)

M Class

VNMG
VNMA

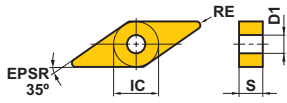

Light Cutting	Medium Cutting	Medium Cutting	Medium Cutting	Medium Cutting	Medium Cutting
LK	MP	MK	GK	MA	MH
Strong Cutting Edge					
Flat Top					

(mm)

Order Number	Cutting Area	Cutting Area			IC	S	RE	D1
		MC5105	MC5115	MC5125				
VNMG160404-LK	L	●	●	●	9.525	4.76	0.4	3.81
VNMG160408-LK	L	●	●	●	9.525	4.76	0.8	3.81
NEW VNMG160404-MP	M		●		9.525	4.76	0.4	3.81
NEW VNMG160408-MP	M		●		9.525	4.76	0.8	3.81
NEW VNMG160412-MP	M		●		9.525	4.76	1.2	3.81
VNMG160404-MK	M	●	●	●	9.525	4.76	0.4	3.81
VNMG160408-MK	M	●	●	●	9.525	4.76	0.8	3.81
VNMG160412-MK	M	●	●	●	9.525	4.76	1.2	3.81
VNMG160404-GK	M	●	●	●	9.525	4.76	0.4	3.81
VNMG160408-GK	M	●	●	●	9.525	4.76	0.8	3.81
VNMG160412-GK	M	●	●	●	9.525	4.76	1.2	3.81
VNMG160404-MA	M	●	●	●	9.525	4.76	0.4	3.81
VNMG160408-MA	M	●	●	●	9.525	4.76	0.8	3.81
NEW VNMG160404-MH	M	●			9.525	4.76	0.4	3.81
NEW VNMG160408-MH	M	●			9.525	4.76	0.8	3.81
VNMA160404	-	●	●	●	9.525	4.76	0.4	3.81
VNMA160408	-	●	●	●	9.525	4.76	0.8	3.81
VNMA160412	-	●	●	●	9.525	4.76	1.2	3.81

● = **NEW**

Negative Inserts (With hole)

M Class

WNMG
WNMA

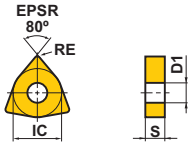

Light Cutting LK	Light Cutting SH	Light Cutting SW (Wiper)	Medium Cutting MP	Medium Cutting MK	Medium Cutting GK
Medium Cutting MA	Medium Cutting MH	Medium Cutting MW (Wiper)	Rough Cutting RK	Rough Cutting GH	Strong Cutting Edge Flat Top

(mm)

Order Number	Cutting Area	MC5105	MC5115	MC5125	IC	S	RE	D1
WNMG080404-LK	L	●	●	●	12.7	4.76	0.4	5.16
WNMG080408-LK	L	●	●	●	12.7	4.76	0.8	5.16
WNMG080412-LK	L	●	●	●	12.7	4.76	1.2	5.16
NEW WNMG080404-SH	L	●	●	●	12.7	4.76	0.4	5.16
NEW WNMG080408-SH	L	●	●	●	12.7	4.76	0.8	5.16
NEW WNMG080412-SH	L	●	●	●	12.7	4.76	1.2	5.16
NEW WNMG080404-SW	L	●	●	●	12.7	4.76	0.4	5.16
NEW WNMG080408-SW	L	●	●	●	12.7	4.76	0.8	5.16
NEW WNMG06T304-MP	M	●	●	●	9.525	3.97	0.4	3.81
NEW WNMG06T308-MP	M	●	●	●	9.525	3.97	0.8	3.81
NEW WNMG06T312-MP	M	●	●	●	9.525	3.97	1.2	3.81
NEW WNMG060404-MP	M	●	●	●	9.525	4.76	0.4	3.81
NEW WNMG060408-MP	M	●	●	●	9.525	4.76	0.8	3.81
NEW WNMG060412-MP	M	●	●	●	9.525	4.76	1.2	3.81
NEW WNMG080404-MP	M	●	●	●	12.7	4.76	0.4	5.16
NEW WNMG080408-MP	M	●	●	●	12.7	4.76	0.8	5.16
NEW WNMG080412-MP	M	●	●	●	12.7	4.76	1.2	5.16
NEW WNMG080416-MP	M	●	●	●	12.7	4.76	1.6	5.16
WNMG080404-MK	M	●	●	●	12.7	4.76	0.4	5.16
WNMG080408-MK	M	●	●	●	12.7	4.76	0.8	5.16
WNMG080412-MK	M	●	●	●	12.7	4.76	1.2	5.16
WNMG080416-MK	M	●	●	●	12.7	4.76	1.6	5.16
WNMG060404-GK	M	●	●	●	9.525	4.76	0.4	3.81
WNMG060408-GK	M	●	●	●	9.525	4.76	0.8	3.81
WNMG080404-GK	M	●	●	●	12.7	4.76	0.4	5.16
WNMG080408-GK	M	●	●	●	12.7	4.76	0.8	5.16
WNMG080412-GK	M	●	●	●	12.7	4.76	1.2	5.16
WNMG080416-GK	M	●	●	●	12.7	4.76	1.6	5.16
WNMG060408-MA	M	●	●	●	9.525	4.76	0.8	3.81
WNMG060412-MA	M	●	●	●	9.525	4.76	1.2	3.81
WNMG080404-MA	M	●	●	●	12.7	4.76	0.4	5.16
WNMG080408-MA	M	●	●	●	12.7	4.76	0.8	5.16
WNMG080412-MA	M	●	●	●	12.7	4.76	1.2	5.16
WNMG080416-MA	M	●	●	●	12.7	4.76	1.6	5.16
WNMG080408-MH	M	●	●	●	12.7	4.76	0.8	5.16
WNMG080412-MH	M	●	●	●	12.7	4.76	1.2	5.16
NEW WNMG060408-MW	M	●	●	●	9.525	4.76	0.8	3.81
NEW WNMG060412-MW	M	●	●	●	9.525	4.76	1.2	3.81
NEW WNMG080408-MW	M	●	●	●	12.7	4.76	0.8	5.16
NEW WNMG080412-MW	M	●	●	●	12.7	4.76	1.2	5.16

Order Number	Cutting Area	MC5105	MC5115	MC5125	IC	S	RE	D1
WNMG080408-RK	R	●	●	●	12.7	4.76	0.8	5.16
WNMG080412-RK	R	●	●	●	12.7	4.76	1.2	5.16
WNMG080416-RK	R	●	●	●	12.7	4.76	1.6	5.16
NEW WNMG080408-GH	R	●	●	●	12.7	4.76	0.8	5.16
NEW WNMG080412-GH	R	●	●	●	12.7	4.76	1.2	5.16
WNMA060408	-	●	●	●	9.525	4.76	0.8	3.81
WNMA060412	-	●	●	●	9.525	4.76	1.2	3.81
WNMA080404	-	●	●	●	12.7	4.76	0.4	5.16
WNMA080408	-	●	●	●	12.7	4.76	0.8	5.16
WNMA080412	-	●	●	●	12.7	4.76	1.2	5.16
WNMA080416	-	●	●	●	12.7	4.76	1.6	5.16

● = NEW

MC5100 Series

Negative Inserts (Without hole)

M Class

CNMN

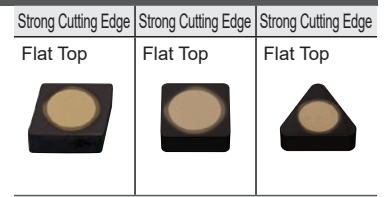
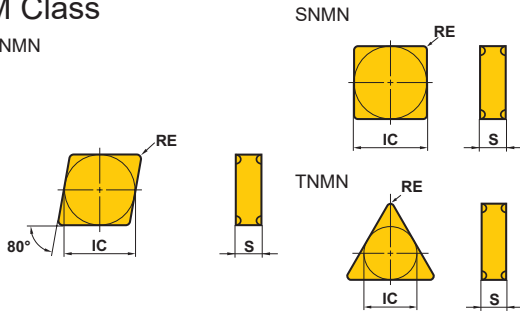

Order Number	Cutting Area	MC5105			IC	S	RE	D1
		MC5105	MC5115	MC5125				
CNMN120408	-	●	●	●	12.7	4.76	0.8	-
CNMN120412	-	●	●	●	12.7	4.76	1.2	-
CNMN120416	-	●	●	●	12.7	4.76	1.6	-
SNMN120408	-	●	●	●	12.7	4.76	0.8	-
SNMN120412	-	●	●	●	12.7	4.76	1.2	-
SNMN120416	-	●	●	●	12.7	4.76	1.6	-
SNMN120420	-	●	●	●	12.7	4.76	2.0	-

(mm)

Order Number	Cutting Area	MC5105			IC	S	RE	D1
		MC5105	MC5115	MC5125				
TNMN160408	-	●	●	●	9.525	4.76	0.8	-
TNMN160412	-	●	●	●	9.525	4.76	1.2	-
TNMN160416	-	●	●	●	9.525	4.76	1.6	-
TNMN160420	-	●	●	●	9.525	4.76	2.0	-

● : Inventory maintained in Japan.
(10 inserts in one case)



5° Positive inserts (With hole)

NEW

M Class

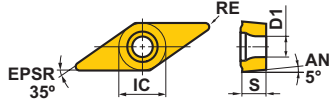
VBMT
VBMW



Medium Cutting	Medium Cutting	Strong Cutting Edge
MK	MV	Flat Top
		

(mm)

Order Number	Cutting Area	MC5105	MC5115	MC5125	IC	S	RE	D1
VBMT160404-MK	M	●	●	●	9.525	4.76	0.4	4.4
VBMT160408-MK	M	●	●	●	9.525	4.76	0.8	4.4
VBMT110304-MV	M		●		6.35	3.18	0.4	2.9
VBMT110308-MV	M		●		6.35	3.18	0.8	2.9
VBMT160404-MV	M		●		9.525	4.76	0.4	4.4
VBMT160408-MV	M		●		9.525	4.76	0.8	4.4
VBMW160408	-	●	●	●	9.525	4.76	0.8	4.4

● = **NEW**

MC5100 Series

7° Positive inserts (With hole)

M Class

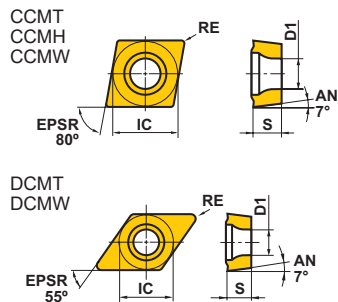

Light Cutting	Medium Cutting	Medium Cutting	Medium Cutting	Strong Cutting Edge
SW  (Wiper)	MK 	MV 	MW  (Wiper)	Flat Top 
Medium Cutting	Medium Cutting	Strong Cutting Edge		
MK 	MV 	Flat Top 		

(mm)

Order Number	Cutting Area	MC5100 Series			IC	S	RE	D1
		MC5105	MC5115	MC5125				
NEW CCMT060204-SW	L		●		6.35	2.38	0.4	2.8
NEW CCMT09T302-SW	L		●		9.525	3.97	0.2	4.4
NEW CCMT09T304-SW	L		●		9.525	3.97	0.4	4.4
NEW CCMT060202-MK	M	●	●	●	6.35	2.38	0.2	2.8
CCMT060204-MK	M	●	●	●	6.35	2.38	0.4	2.8
CCMT060208-MK	M	●	●	●	6.35	2.38	0.8	2.8
NEW CCMT09T302-MK	M	●	●	●	9.525	3.97	0.2	4.4
CCMT09T304-MK	M	●	●	●	9.525	3.97	0.4	4.4
CCMT09T308-MK	M	●	●	●	9.525	3.97	0.8	4.4
CCMT120404-MK	M	●	●	●	12.7	4.76	0.4	5.5
CCMT120408-MK	M	●	●	●	12.7	4.76	0.8	5.5
CCMT120412-MK	M	●	●	●	12.7	4.76	1.2	5.5
NEW CCMH060204-MV	M		●		6.35	2.38	0.4	2.8
NEW CCMT120404-MW	M		●		12.7	4.76	0.4	5.5
NEW CCMT120408-MW	M		●		12.7	4.76	0.8	5.5
NEW CCMW060204	-	●	●	●	6.35	2.38	0.4	2.8
NEW CCMW060208	-	●	●	●	6.35	2.38	0.8	2.8
NEW CCMW09T304	-	●	●	●	9.525	3.97	0.4	4.4
NEW CCMW09T308	-	●	●	●	9.525	3.97	0.8	4.4
NEW CCMW09T312	-	●	●	●	9.525	3.97	1.2	4.4
NEW CCMW120404	-	●	●	●	12.7	4.76	0.4	5.5
NEW CCMW120408	-	●	●	●	12.7	4.76	0.8	5.5
NEW CCMW120412	-	●	●	●	12.7	4.76	1.2	5.5

Order Number	Cutting Area	MC5100 Series			IC	S	RE	D1
		MC5105	MC5115	MC5125				
NEW DCMT070202-MK	M	●	●	●	6.35	2.38	0.2	2.8
DCMT070204-MK	M	●	●	●	6.35	2.38	0.4	2.8
DCMT070208-MK	M	●	●	●	6.35	2.38	0.8	2.8
NEW DCMT11T302-MK	M	●	●	●	9.525	3.97	0.2	4.4
DCMT11T304-MK	M	●	●	●	9.525	3.97	0.4	4.4
DCMT11T308-MK	M	●	●	●	9.525	3.97	0.8	4.4
DCMT150404-MK	M	●	●	●	12.7	4.76	0.4	5.5
DCMT150408-MK	M	●	●	●	12.7	4.76	0.8	5.5
NEW DCMT070204-MV	M		●		6.35	2.38	0.4	2.8
NEW DCMT070208-MV	M		●		6.35	2.38	0.8	2.8
NEW DCMT11T304-MV	M		●		9.525	3.97	0.4	4.4
NEW DCMT11T308-MV	M		●		9.525	3.97	0.8	4.4
NEW DCMW070204	-	●	●	●	6.35	2.38	0.4	2.8
NEW DCMW11T304	-	●	●	●	9.525	3.97	0.4	4.4
NEW DCMW11T308	-	●	●	●	9.525	3.97	0.8	4.4

● = NEW

7° Positive Inserts (With Hole)

NEW

M Class

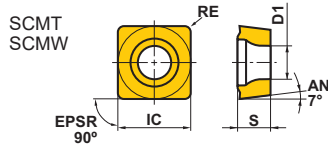
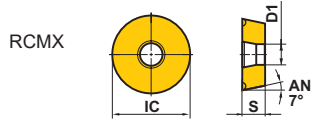

Medium Cutting	
Standard	
Medium Cutting	Strong Cutting Edge
MK	Flat Top

(mm)

Order Number	Cutting Area	MC5105	MC5115	MC5125	IC	S	RE	D1
RCMX1204M0	M		●		12.7	4.76	-	4.2

Order Number	Cutting Area	MC5105	MC5115	MC5125	IC	S	RE	D1
SCMT09T304-MK	M	●	●	●	9.525	3.97	0.4	4.4
SCMT09T308-MK	M	●	●	●	9.525	3.97	0.8	4.4
SCMT120404-MK	M	●	●	●	12.7	4.76	0.4	5.5
SCMT120408-MK	M	●	●	●	12.7	4.76	0.8	5.5
SCMW09T304	-	●	●	●	9.525	3.97	0.4	4.4
SCMW09T308	-	●	●	●	9.525	3.97	0.8	4.4
SCMW120408	-	●	●	●	12.7	4.76	0.8	5.5

● = **NEW**

MC5100 Series

7° Positive Inserts (With Hole)

NEW

M Class

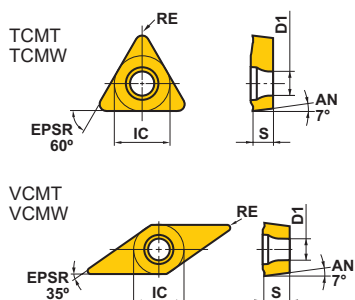

Light Cutting	Medium Cutting	Strong Cutting Edge
LK	MK	Flat Top
Medium Cutting	Medium Cutting	Strong Cutting Edge
MK	MV	Flat Top

(mm)

Order Number	Cutting Area	MC5100 Series			IC	S	RE	D1
		MC5105	MC5115	MC5125				
TCMT110202-LK	L	●	●	●	6.35	2.38	0.2	2.8
TCMT110204-LK	L	●	●	●	6.35	2.38	0.4	2.8
TCMT110208-LK	L	●	●	●	6.35	2.38	0.8	2.8
TCMT110204-MK	M	●	●	●	6.35	2.38	0.4	2.8
TCMT110208-MK	M	●	●	●	6.35	2.38	0.8	2.8
TCMT16T304-MK	M	●	●	●	9.525	3.97	0.4	4.4
TCMT16T308-MK	M	●	●	●	9.525	3.97	0.8	4.4
TCMT16T312-MK	M	●	●	●	9.525	3.97	1.2	4.4
TCMW110204	-	●	●	●	6.35	2.38	0.4	2.8
TCMW16T304	-	●	●	●	9.525	3.97	0.4	4.4
TCMW16T308	-	●	●	●	9.525	3.97	0.8	4.4
TCMW16T312	-	●	●	●	9.525	3.97	1.2	4.4

Order Number	Cutting Area	MC5100 Series			IC	S	RE	D1
		MC5105	MC5115	MC5125				
VCMT160404-MK	M	●	●	●	9.525	4.76	0.4	4.4
VCMT160408-MK	M	●	●	●	9.525	4.76	0.8	4.4
VCMT080204-MV	M		●		4.76	2.38	0.4	2.4
VCMW160404	-	●	●	●	9.525	4.76	0.4	4.4
VCMW160408	-	●	●	●	9.525	4.76	0.8	4.4

● = **NEW**

11° Positive Inserts (With Hole)

NEW

M Class

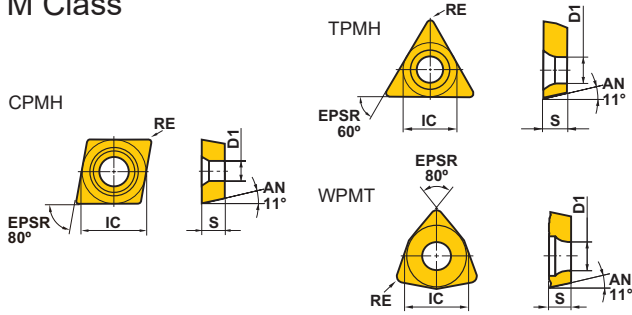

Medium Cutting	Medium Cutting	Light Cutting	Medium Cutting
MK	MV	LK	MV
Medium Cutting			
MV			

(mm)

Order Number	Cutting Area	Cutting Area			IC	S	RE	D1
		MC5105	MC5115	MC5125				
CPMH080204-MK	M	●	●	●	7.94	2.38	0.4	3.5
CPMH080208-MK	M	●	●	●	7.94	2.38	0.8	3.5
CPMH090304-MK	M	●	●	●	9.525	3.18	0.4	4.5
CPMH090308-MK	M	●	●	●	9.525	3.18	0.8	4.5
CPMH080204-MV	M		●		7.94	2.38	0.4	3.5
CPMH080208-MV	M		●		7.94	2.38	0.8	3.5
CPMH090304-MV	M		●		9.525	3.18	0.4	4.5
CPMH090308-MV	M		●		9.525	3.18	0.8	4.5

Order Number	Cutting Area	Cutting Area			IC	S	RE	D1
		MC5105	MC5115	MC5125				
TPMH110302-LK	L	●	●	●	6.35	3.18	0.2	3.4
TPMH110304-LK	L	●	●	●	6.35	3.18	0.4	3.4
TPMH110308-LK	L	●	●	●	6.35	3.18	0.8	3.4
TPMH160302-LK	L	●	●	●	9.525	3.18	0.2	4.4
TPMH160304-LK	L	●	●	●	9.525	3.18	0.4	4.4
TPMH160308-LK	L	●	●	●	9.525	3.18	0.8	4.4
TPMH080204-MV	M		●		4.76	2.38	0.4	2.4
TPMH090204-MV	M		●		5.56	2.38	0.4	2.9
TPMH090208-MV	M		●		5.56	2.38	0.8	2.9
TPMH110304-MV	M		●		6.35	3.18	0.4	3.4
TPMH110308-MV	M		●		6.35	3.18	0.8	3.4
TPMH160304-MV	M		●		9.525	3.18	0.4	4.4
TPMH160308-MV	M		●		9.525	3.18	0.8	4.4
WPMT040204-MV	M		●		6.35	2.38	0.4	2.8
WPMT060304-MV	M		●		9.525	3.18	0.4	4.4
WPMT060308-MV	M		●		9.525	3.18	0.8	4.4

● = **NEW**

MC5100 Series

11° Positive Inserts (Without Hole) NEW

M Class

TPMR
TPMN

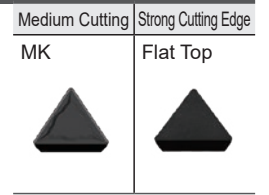
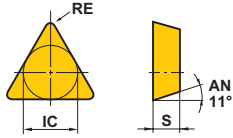

(mm)

Order Number	Cutting Area	Cutting Area			IC	S	RE	D1
		MC5105	MC5115	MC5125				
TPMR110304-MK	M	●	●	●	6.35	3.18	0.4	-
TPMR110308-MK	M	●	●	●	6.35	3.18	0.8	-
TPMR160304-MK	M	●	●	●	9.525	3.18	0.4	-
TPMR160308-MK	M	●	●	●	9.525	3.18	0.8	-
TPMN110304	-	●	●	●	6.35	3.18	0.4	-
TPMN110308	-	●	●	●	6.35	3.18	0.8	-
TPMN160304	-	●	●	●	9.525	3.18	0.4	-
TPMN160308	-	●	●	●	9.525	3.18	0.8	-
TPMN160312	-	●	●	●	9.525	3.18	1.2	-

● = NEW

Recommended Cutting Conditions

Negative Inserts (For External Turning)

Workpiece Material	Properties	Cutting Conditions	Grade	Cutting Speed v_c (m/min)	
K	Gray Cast Iron	Tensile Strength $\leq 350\text{MPa}$	●	MC5105	230–700
			●	MC5105	210–640
			⊕	MC5105	195–605
			⊕	MC5115	190–350
	Ductile Cast Iron	Tensile Strength $\leq 450\text{MPa}$	●	MC5115	195–365
			●	MC5115	180–330
			⊕	MC5125	95–190
		Tensile Strength $\leq 800\text{MPa}$	●	MC5115	175–325
			●	MC5115	160–295
			⊕	MC5125	85–170

Cutting Area	Chip Breaker	Feed f (mm/rev)	Depth of Cut a_p
Light Cutting	LK	0.15–0.50	0.5–2.5
	SH	0.10–0.40	0.3–2.0
	SW	0.10–0.50	0.3–2.5
Medium Cutting	MK	0.20–0.55	0.5–4.0
	GK	0.20–0.60	1.5–5.0
	MP	0.16–0.50	0.3–4.0
	MA	0.20–0.50	0.3–4.0
	MH	0.20–0.55	1.0–4.0
	MW	0.20–0.60	0.9–4.0
Rough Cutting	RK	0.20–0.60	1.5–6.0
	GH	0.25–0.60	1.5–6.0
Heavy Cutting	Flat Top	0.20–0.60	2.5–6.0

Cutting Conditions : ● : Stable Cutting ● : General Cutting ⊕ : Unstable Cutting

CVD Coated Grades for Cast Iron Turning

Recommended Cutting Conditions

5°, 7° Positive Inserts (For External Turning)

Workpiece Material	Properties	Cutting Conditions	Grade	Cutting Speed vc (m/min)	
K	Gray Cast Iron	●	MC5115	190–350	
		●	MC5115	140–270	
		⊕	MC5115	80–150	
	Ductile Cast Iron	Tensile Strength ≤450MPa	●	MC5115	170–320
			●	MC5115	130–250
			⊕	MC5125	60–130
		Tensile Strength ≤800MPa	●	MC5115	125–240
			●	MC5115	105–200
			⊕	MC5125	55–115

11° Positive Inserts (For External Turning)

Workpiece Material	Properties	Cutting Conditions	Grade	Cutting Speed vc (m/min)	
K	Gray Cast Iron	●	MC5115	150–300	
		●	MC5115	140–270	
		⊕	MC5115	80–150	
	Ductile Cast Iron	Tensile Strength ≤450MPa	●	MC5115	170–320
			●	MC5115	130–250
			⊕	MC5125	60–130
		Tensile Strength ≤800MPa	●	MC5115	125–240
			●	MC5115	105–200
			⊕	MC5125	55–115

Cutting Area	Chip Breaker	Feed f (mm/rev)	Depth of Cut ap
Light Cutting	LK	0.06–0.25	0.2–1.0
	SW	0.06–0.24	0.2–1.5
Medium Cutting	MK	0.08–0.30	0.3–2.0
	MV	0.08–0.30	0.3–2.0
	Standard	0.08–0.30	0.3–2.0
	MW	0.10–0.35	0.8–2.5
Heavy Cutting	Flat Top	0.08–0.30	0.3–2.0

Cutting Conditions : ● : Stable Cutting ● : General Cutting ⊕ : Unstable Cutting

Examples of Usage

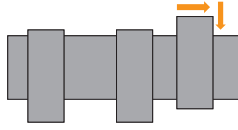
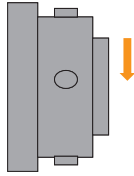
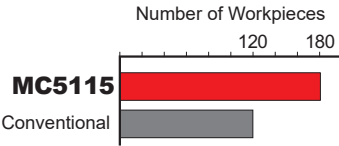
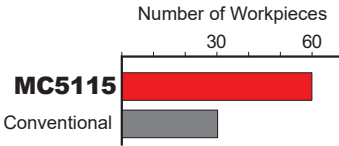
Insert		VNMG160408-GK	CNMA120412	
Workpiece Material	JIS FCD700			
	Automotive Parts	Automotive Parts	Automotive Parts	
Application		External Turning and Facing	Facing	
Cutting Conditions	Cutting Speed v_c (m/min)	150	220	
	Feed per Rev. f (mm/rev)	0.2-0.35	0.22-0.25	
	Depth of Cut a_p (mm)	1.0-3.0	2.0-2.5	
Cutting Mode		Wet Cutting	—	
Results	 <p>The tool life was stable and 1.5 times longer than conventional products.</p>		 <p>Compared to conventional products, the amount of wear has been suppressed and the number of workpieces processed has been doubled.</p>	

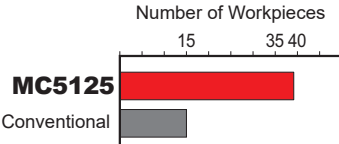
Insert		CNMG120412-RK	
Workpiece Material	JIS FCD450		
	Machine Parts	Machine Parts	
Application		Rough Cutting of External and Face	
Cutting Conditions	Cutting Speed v_c (m/min)	160	
	Feed per Rev. f (mm/rev)	0.2	
	Depth of Cut a_p (mm)	2.5-3.5	
Cutting Mode		Wet Cutting	
Results	 <p>It was confirmed that the fracture resistance was twice as high as that of conventional products during heavy interrupted machining.</p>		

The application examples are from customers workpieces and can therefore differ from the recommended cutting conditions.



CVD Coated Grades for Cast Iron Turning

MC5100 Series

Environmentally Friendly Product

This product has been certified as an environmentally friendly product in the machine tool industry by the Japan Cutting & Wear-resistant Tool Association. This is a product unique to the industry, in harmony with the environment, and with the aim of fulfilling the social responsibilities of the machine tool industry.

The Japan Cutting & Wear-resistant Tool Association evaluates the product's environmental impact during the manufacturing and usage stages and issues a certification according to the evaluation score.



For People, Society and the Earth

More information about MITSUBISHI MATERIALS' efforts to address social and environmental issues can be found in the website below or by scanning the QR code.

<https://mmc.disclosure.site/en/>



For Your Safety

●Don't handle inserts and chips without gloves. ●Please machine within the recommended application range and exchange expired tools with new ones in advance of breakage. ●Please use safety covers and wear safety glasses. ●When using compounded cutting oils, please take fire precautions. ●When attaching inserts or spare parts, please use only the correct wrench or driver. ●When using rotating tools, please make a trial run to check run-out, vibration and abnormal sounds etc.

This brochure is published by

 **MITSUBISHI MATERIALS CORPORATION**

MITSUBISHI MATERIALS CORPORATION

Overseas Sales Dept, Asian Region

Marunouchi Nijubashi Building 22F, 3-2-3, Marunouchi, Chiyoda-ku, Tokyo 100-8117, Japan

Overseas Sales Dept, European & American Region

Marunouchi Nijubashi Building 22F, 3-2-3, Marunouchi, Chiyoda-ku, Tokyo 100-8117, Japan

<http://www.mmc-carbide.com/>

(Tools specifications subject to change without notice.)