

Double Sided Insert Type Shoulder Mill

Environmentally Friendly Product

# WWX Series

Series  
Expansion

## Highly Rigid Body for Excellent Performance

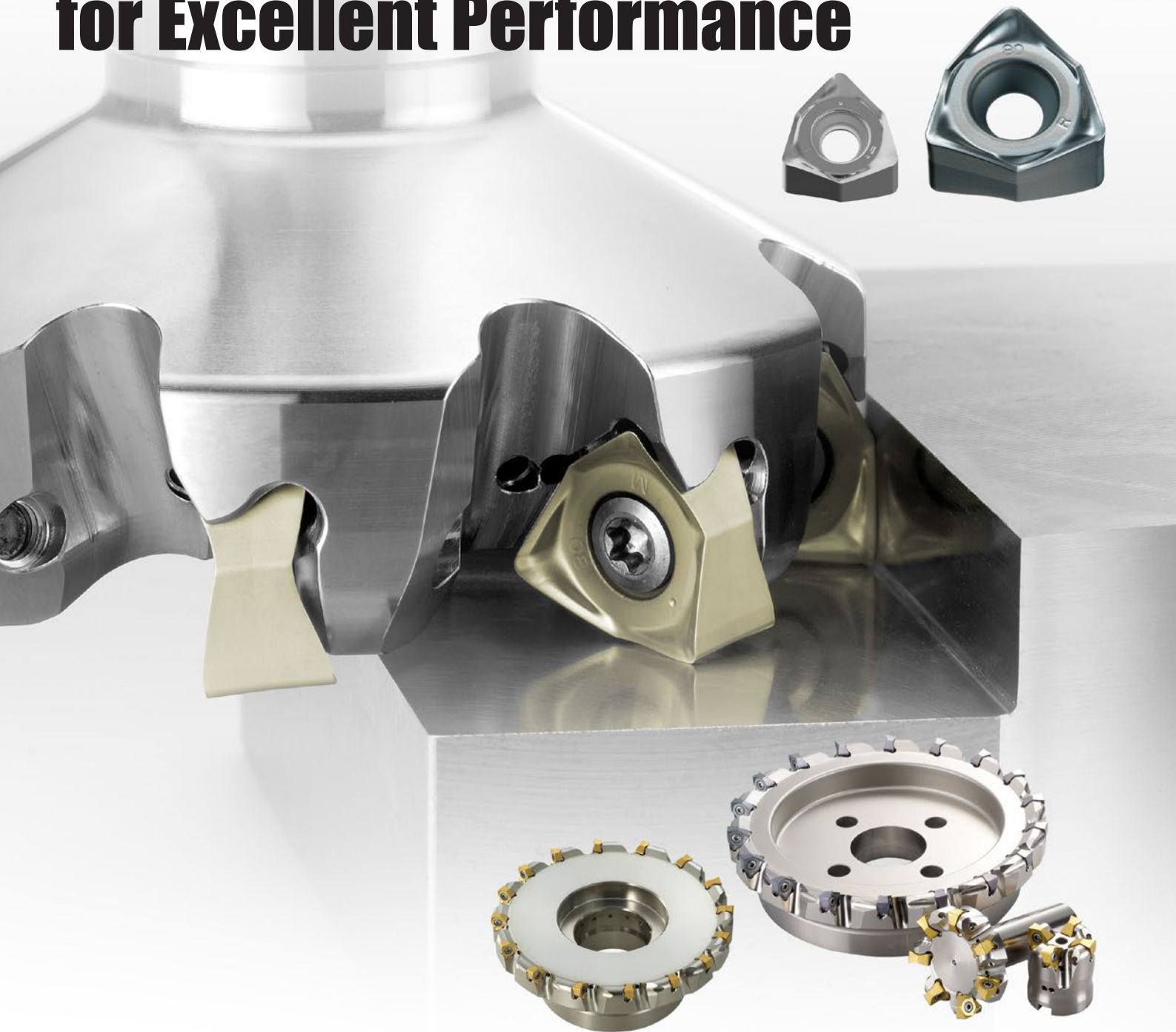

Strong  Geometry

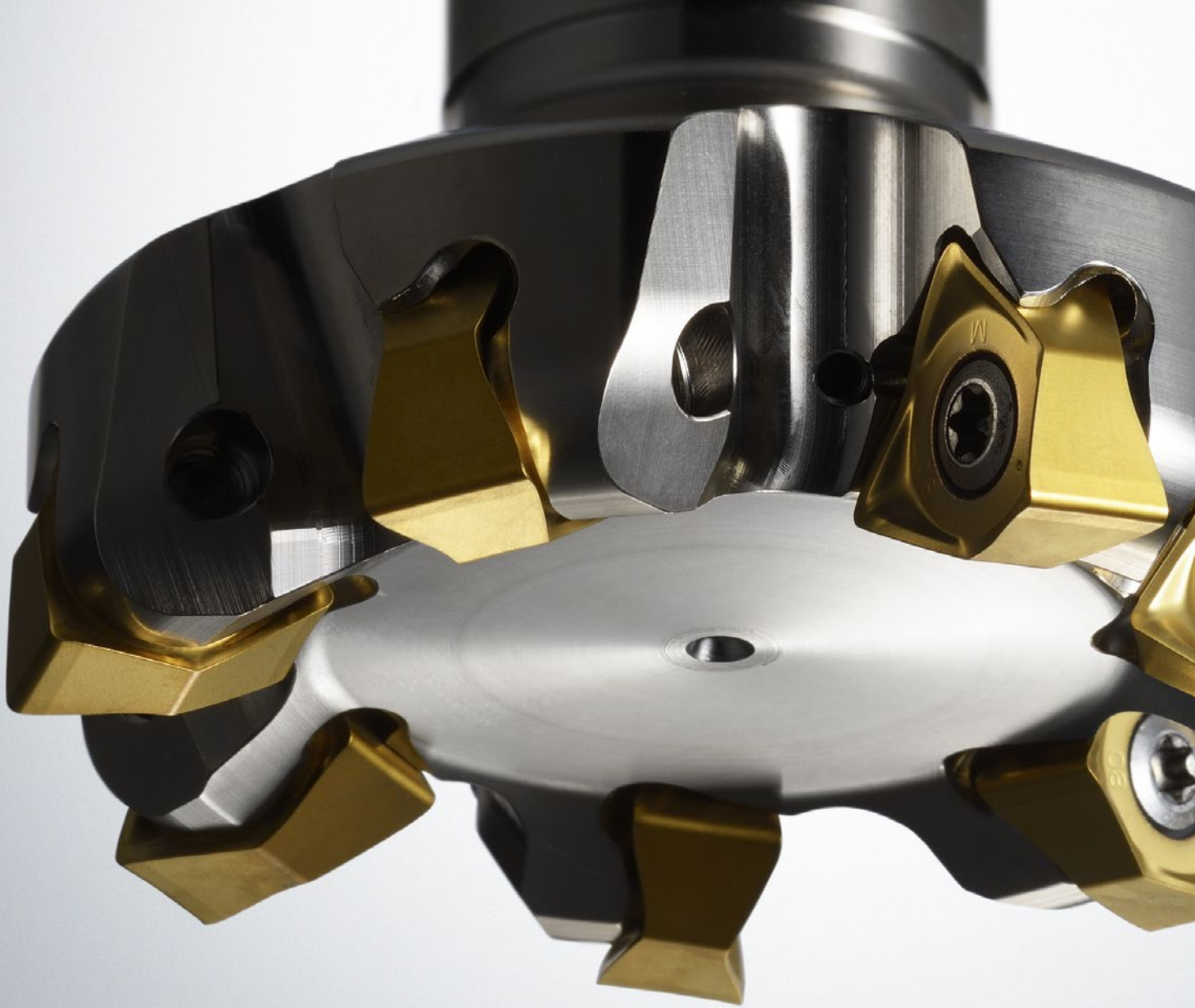

Double Sided Insert Type Shoulder Mill

# WWX Series

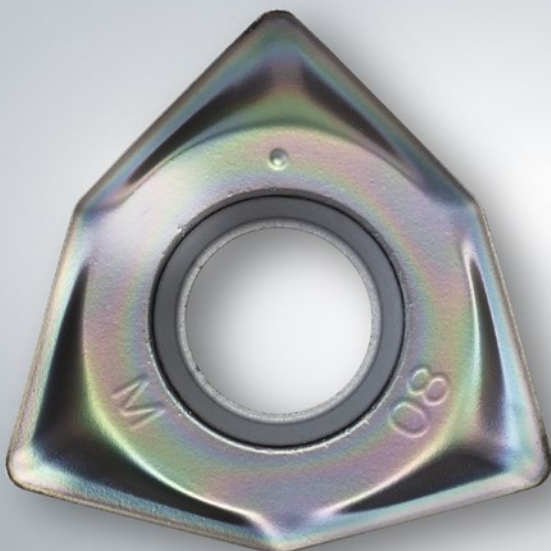

Economical double sided insert with 6 corners.



The insert thickness was greatly increased to markedly improve fracture resistance (MMC comparison).



**WWX200**

**WWX400**

Please refer to the last page for more information on certified environmentally friendly products.



# Stable and Reliable

The optimised "X-type" insert enables stable, high quality machining.

Strong  Geometry



Tool body damage is negated due to the radial geometry behind the insert.



Are available to machine a vast range of materials.



The optimised “X-type” insert meets the demand for greater strength.



YouTube

## ■ The “X-Type” insert shape provides economic efficiency as well as maintaining high quality surface finishes.

A 90° wall surface is produced and the large R-wiper edge achieves good surface finishes. In addition the optimised X-type insert with 6 corners contributes to lower tooling costs.

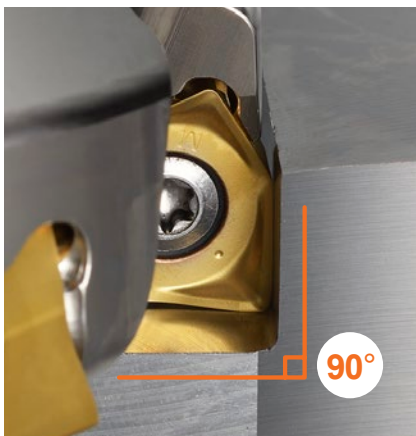

High-quality wall surface machining is possible.

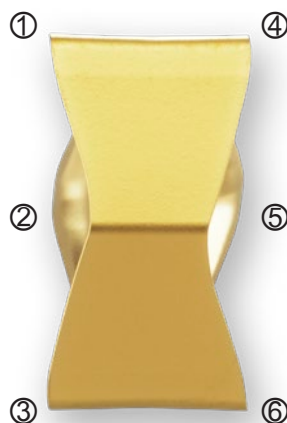

Economical double sided 6 corners.

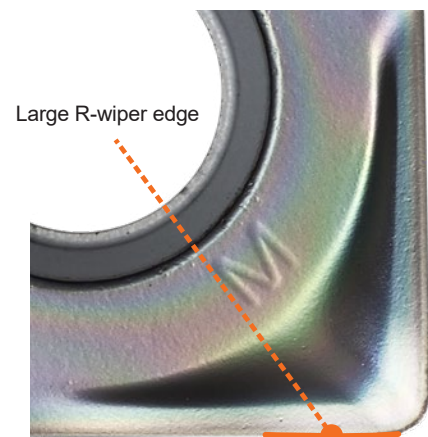

Large R-wiper edge achieves good surface finishes.

## The generous thickness of the insert provides high rigidity.

The new WWX200 insert is 1.5 times thicker than a conventional ASX400 insert, and the WWX400 is 2.2 times thicker. This extra thickness provides higher rigidity and fracture resistance. Additionally, the extra rigidity eliminates the need for a shim. Therefore direct clamping of the insert to the body provides extra stability.

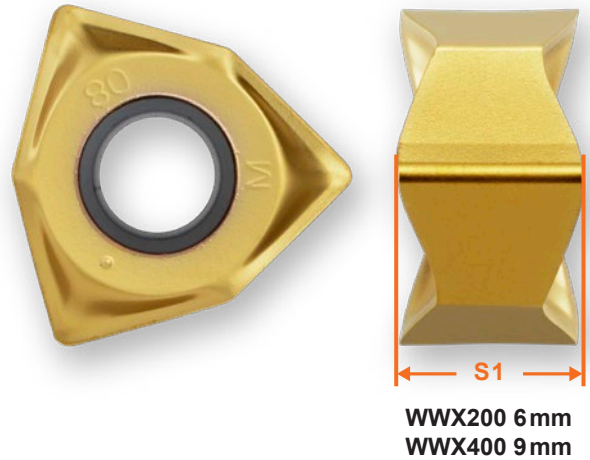

## Strong X Geometry

## Excellent control and chip abrasion prevention.

CAE\* analysis was used for the main cutting edge design. This resulted in changing from a straight to a curved cutting edge. Additionally, the rake angle shape of the optimised cutting edge greatly suppresses the scattering of chips on the finished surface. This enables good surface finishes and markedly improved efficiency.

\*CAE : Computer Aided Engineering

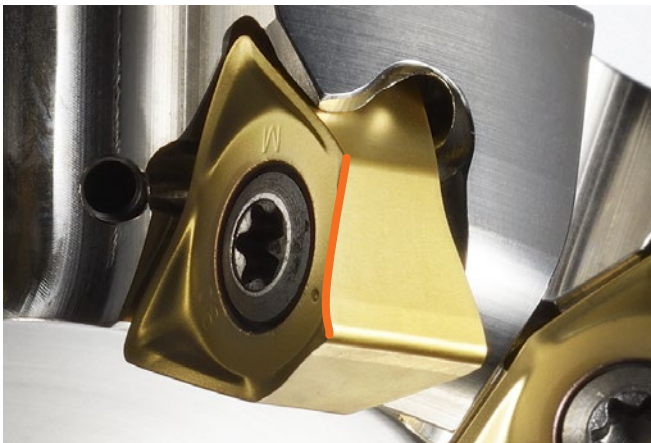

Curved cutting edge shape designed with an optimum rake face.

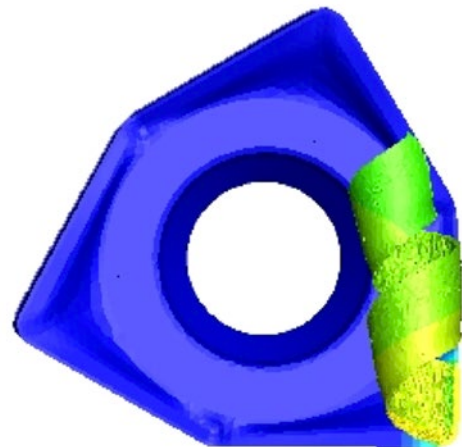

Chips are created in a helical shape for efficient dispersal.



YouTube

## Comments from the Developer

The WWX Series was developed under the concept of "Stable and Worry-free" using an optimised insert shape with a maximum thickness of 9mm in response to recent trends of unmanned operations and the demand for increased efficiency. The main attributes improved were rigidity and fracture resistance. Attention was also given to the cutting edge shape to achieve improved finished surface quality and good chip discharge. The proprietary "X-type" insert developed by Mitsubishi Materials provides extra reliability.



# Extreme clamping stability and high-quality machining.



## Optimised support under the insert and high clamping rigidity improves stability.

The conical shaped seating surface widely supports the insert seating surface while the radial geometry of the tool body behind the insert provides necessary clearance to suppress body damage from scratches and chip abrasion. Additionally, the strong clamping force of the screws provides robust clamping.

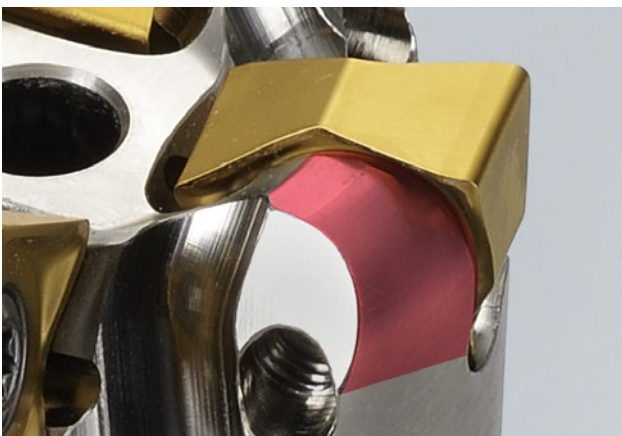

Radius geometry of the tool body behind the insert.

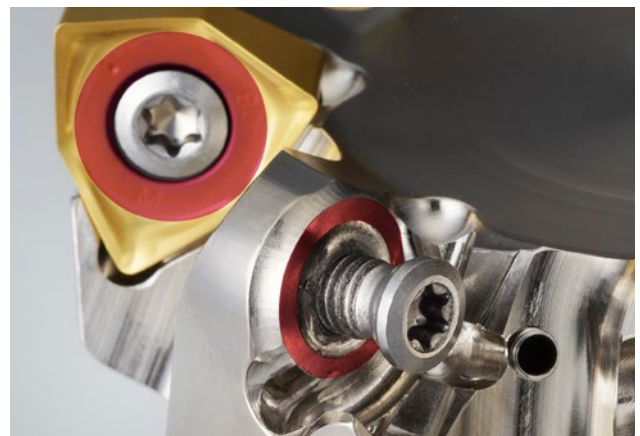

The conical shim surface and the M5 screw for WWX400, and the M3 screw for WWX200 provide a high clamping force.

## Low cutting resistance suppresses chatter and vibration even for thin workpieces.

Although a double-sided insert type with an axial rake angle of 9° (close to that of a single-sided insert type) is used, the WWX400 insert achieves lower cutting resistance than a single-sided insert (in-house comparison) and suppresses chatter and vibration when machining thin workpieces.

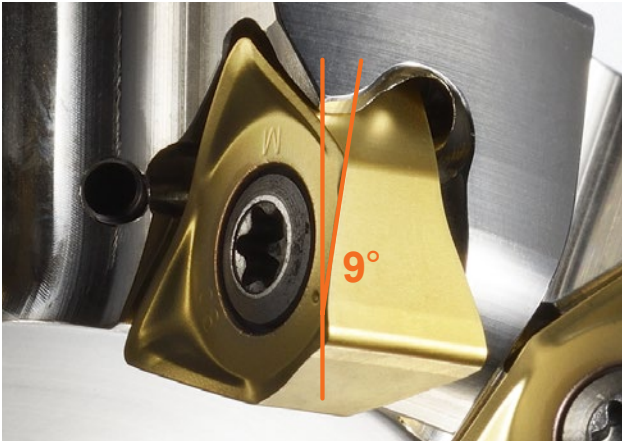

Axial Rake Angle of 9°

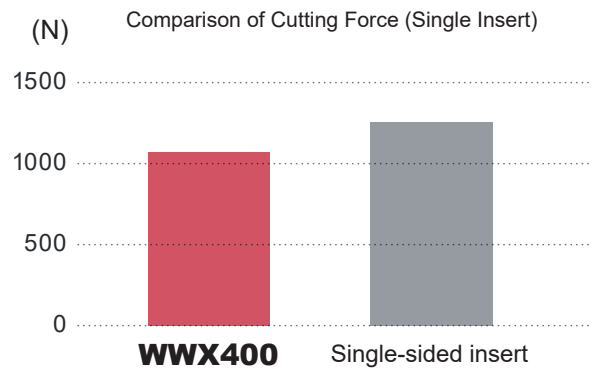

<Cutting Conditions>  
 Workpiece Material : JIS SCM440  
 Cutter Dia. : DC=80 mm  
 Cutting Speed : vc=160 m/min  
 Feed per Tooth : fz=0.2 mm/t.  
 Depth of Cut : ap=2.0 mm  
 Width of Cut : ae=64 mm  
 Cutting Mode : Dry Cutting



YouTube

## Variety of cutter types, diameters & pitches.

Increasing the insert thickness, while achieving a shim-less clamping face made it possible to incorporate a large number of teeth while maintaining large chip pockets to provide a variety of cutter options. A standard inventory is maintained consisting of 3 pitch types of both arbor and shank type cutters of the same diameter.

Fine pitch types in particular allow a high table feed and greatly improve efficiency.



DC=ø80mm  
Fine Pitch Type



DC=ø80mm  
Coarse Pitch Type

## Comments from the Developer

The pursuit of "trouble free machining" is also reflected in the cutter body. The highly rigid radial insert support achieves a stable insert seating face by using a conical shaped shim and M5 screws. This design allows for long and continued use and is the answer to the dissatisfaction experienced when damage to the insert also results in damage to the cutter body.

## WWX Series Classification

### ■ Arbor Type

The table feed is calculated from the recommended conditions of an M breaker for mild steel, during dry, stable cutting and with a cutting width of 0.5DC. APMX is the maximum depth of cut which differs from the recommended cutting conditions.

DC	WWX200 APMX 5.0 mm						WWX400 APMX 8.2 mm					
	No.T*	Table Feed (mm/min)	No.T*	Table Feed (mm/min)	No.T*	Table Feed (mm/min)	No.T*	Table Feed (mm/min)	No.T*	Table Feed (mm/min)	No.T*	Table Feed (mm/min)
40	3	745	4	994	–	–	–	–	–	–	–	–
50	4	795	5	994	6	1192	3	596	4	795	–	–
63	5	789	6	946	7	1104	3	473	4	631	5	789
80	5	621	7	869	9	1118	4	497	5	621	7	869
100	6	596	8	795	11	1093	5	497	7	696	9	894
125	7	556	11	874	14	1113	6	477	8	636	12	954
160	9	559	12	745	16	994	8	497	10	621	14	869
200	–	–	–	–	–	–	10	497	12	596	16	795
250	–	–	–	–	–	–	12	477	14	556	18	715

\* Number of Teeth

### ■ Shank Type

DC	WWX200 APMX 5.0 mm						WWX400 APMX 8.2 mm					
	DCONMS	Functional Length LF		Number of Teeth			DCONMS	Functional Length LF	Number of Teeth			
25	20	115	–	2	–	–	–	–	–	–	–	
	25	115	170	2	–	–	–	–	–	–	–	
28	25	115	170	2	–	–	–	–	–	–	–	
30	25	125	–	2	–	–	–	–	–	–	–	
32	32	125	–	2	3	–	–	–	–	–	–	
	32	190	–	3	–	–	–	–	–	–	–	
35	32	190	–	3	–	–	–	–	–	–	–	
40	32	125	–	3	4	–	–	–	–	–	–	
50	32	125	–	4	5	6	32	125	3	4	–	
63	–	–	–	–	–	–	32	125	3	4	5	
80	–	–	–	–	–	–	32	125	4	5	7	



# Inserts Grades for WWX Series

Inserts grades for a wide range of materials

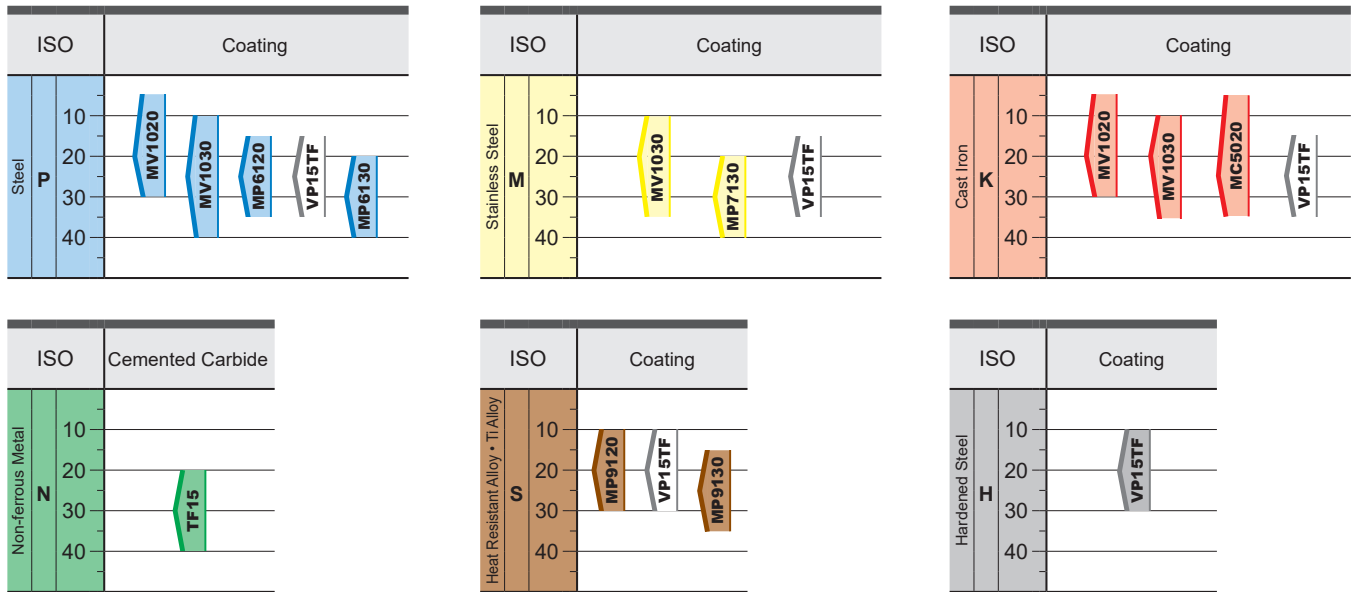

## MP6100/MP7100/MP9100 Series

### TOUGH-Σ Technology

A fusion of the separate coating technologies; PVD and multi-layering provides extra toughness.

**Base Layer**  
**High Al-(Al, Ti)N**

The new technology Al-(Al, Ti)N coating provides stabilisation of the high hardness phase and succeeds in dramatically improving wear, crater and welding resistance.

\*Graphical Representation.

**Al-Ti-Cr-N Based PVD Coating**

\*Graphical Representation.

**Best Layer for Each Work Material**

<b>P</b>	(Al,Cr)N	
	<b>Tough! Thermal Cracks</b>	Thermal Cracks
<b>M</b>	TiN	
	<b>Tough! Notching</b>	Notching
<b>S</b>	CrN	
	<b>Tough! Resistant to Chipping</b>	Welding by Chipping

## CVD Coating MC5020

First recommendation for cast iron milling.

MC5020 has excellent wear resistance and also controls thermal cracking and chipping that are common when machining ductile cast iron.

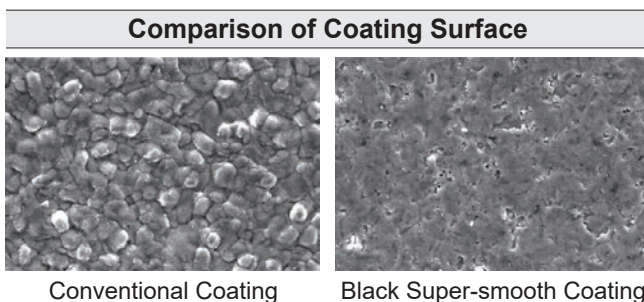

### Black Super-smooth Coating

Black super-smooth coating prevents abnormal damage such as weld chipping.

## Coated Carbide Grade for Milling

# MV1020/MV1030

## Newly Developed Al-Rich Coating

## Advanced Wear and Thermal Shock Resistant

By adopting the newly developed Al-Rich coating technology, the (Al,Ti)N with a high Al content ratio displays a very high hardness. This greatly improves oxidation and wear resistance.

The extreme heat resistance of this new series achieves amazing stability not only during dry cutting, but also when wet cutting where inserts are usually prone to thermal cracking.

MV1020 offers overwhelmingly superior performance in high-speed cutting, and MV1030 achieves stable performance during interrupted and stainless steel machining.

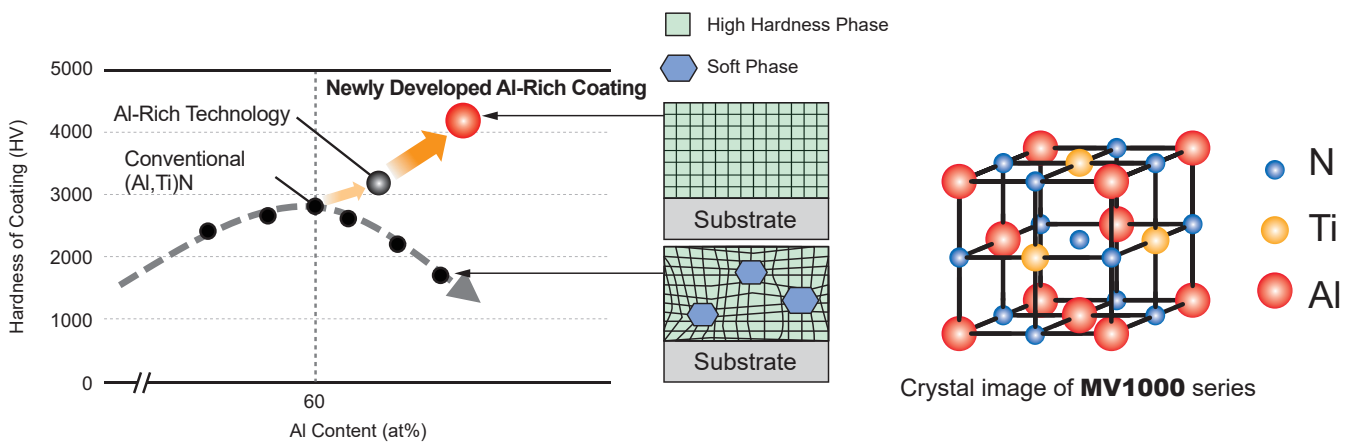

## Cutting Performance

### Comparison of wear resistance when machining alloy steel SCM440

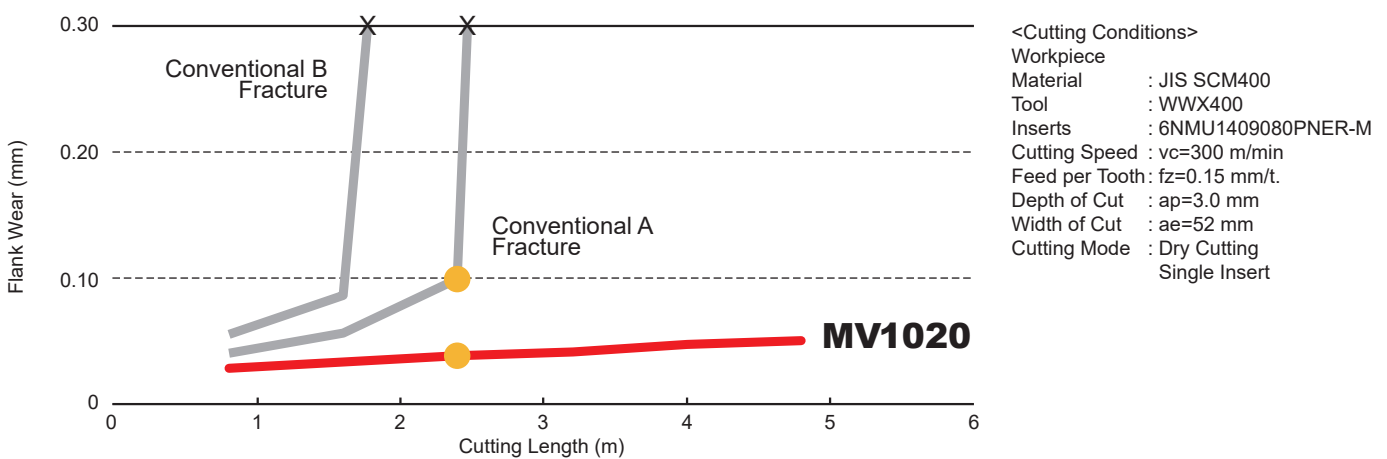

Taken after cutting length of 2.4 m

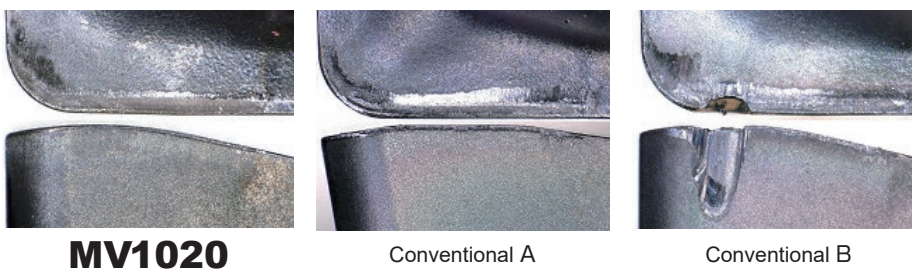

# Chip Breaker System

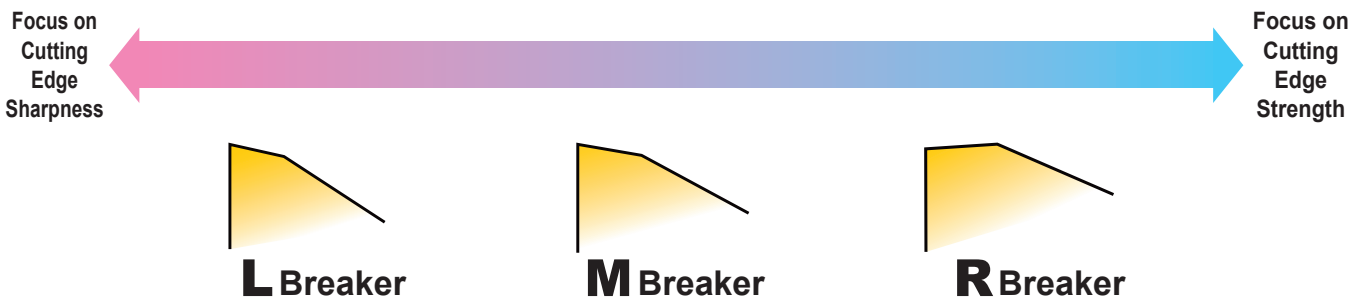

Workpiece Material	Cutting Conditions		
	Stable Cutting	General Cutting	Unstable Cutting
<b>P</b>	L	M	R
<b>M</b>	L	M	
<b>K</b>	L	M	R
<b>N</b>	L		
<b>S</b>	L	M	R
<b>H</b>	L	M	R

## L chip breaker ideal for machining aluminium alloys and non-ferrous metals

Cost advantage of using 6 corners.  
 Precision grade provides high adhesion resistance and excellent machined surface quality.  
 Low cutting force and good chip control.

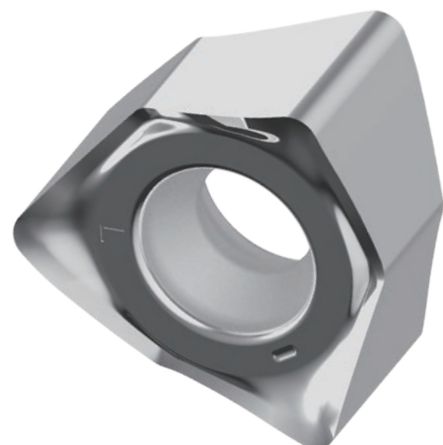

## Cutting Performance

### Finished Surface Comparison after Single Insert Machining of JIS SCM440

WWX400 M class inserts achieve excellent surface finishes, better than conventional G class products.

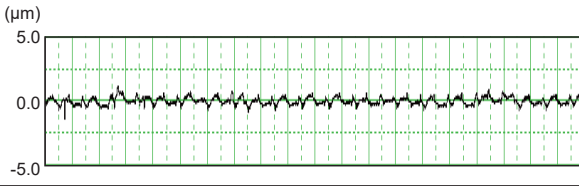
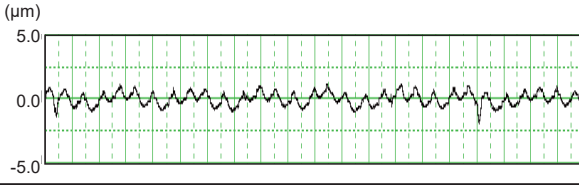
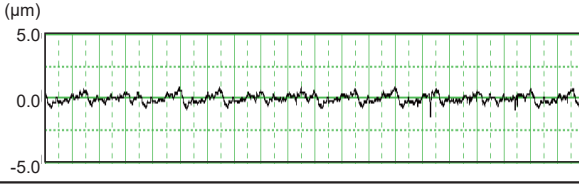
	Ra(μm)	Rz(μm)	Measured Value
<b>WWX400</b> MP6120 (M class)	<b>0.23</b>	<b>1.36</b>	
Conventional (M class)	0.40	2.28	
Conventional (G class)	0.29	1.71	

<Cutting Conditions>

Workpiece Material : JIS SCM440  
 Cutter Dia. : DC=ø80 mm  
 Cutting Speed : vc = 220 m/min  
 Feed per Tooth : fz = 0.1 mm/t.  
 Depth of Cut : ap = 1.0 mm  
 Width of Cut : ae = 64 mm (0.8DC)  
 Cutting Mode : Dry Cutting

### Fracture Resistance Comparison when Machining JIS SCM440

High stability is achieved without fracturing even at a feed of fz=0.35 mm/t.

fz (mm/t.)	0.2	0.25	0.3	0.35
Item				
<b>WWX400</b> MP6120 (Grade M)	<b>Yes</b>	<b>Yes</b>	<b>Yes</b>	<b>Yes</b>
Conventional Single-sided Insert	<b>No</b>			

**Yes** : Cutting length 1620 mm possible

**No** : Fracture

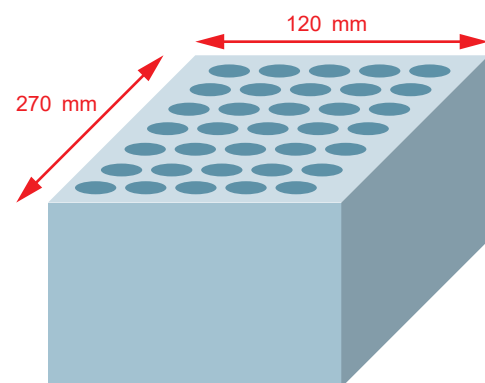

810 mm × 2 = 1620 mm

<Cutting Conditions>

Workpiece Material : JIS SCM440  
 Cutter Dia. : DC=ø80 mm  
 Cutting Speed : vc = 140 m/min  
 Depth of Cut : ap = 2.0 mm  
 Width of Cut : ae = 40 mm (0.5DC)  
 Cutting Mode : Dry Cutting  
 Single Insert

## Comparison of Wall after Shoulder Milling Alloy Steel SCM440

Excels in chip control and achieves excellent, scratch-free wall surfaces.

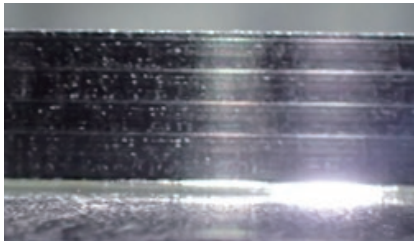

**WWX200**

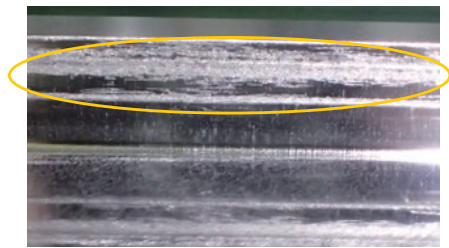

Damage caused by Chips  
Conventional A

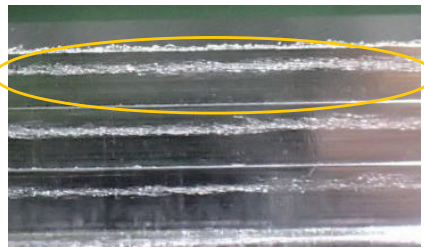

Damage caused by Chips  
Conventional B

<Cutting Conditions>  
 Workpiece Material : JIS SCM440  
 Cutter Dia. : DC=φ50 mm  
 Cutting Speed : vc = 180 m/min  
 Feed per Tooth : fz = 0.1 mm/t.  
 Depth of Cut : ap = 1.0 mm  
 Width of Cut : ae = 40 mm  
 Cutting Mode : Dry Cutting  
 Single Insert

## Comparison of Overall Cutting Length when Machining Alloy Steel SCM440

Displays excellent wear and fracture resistance, and contributes to the extension of cutting length.

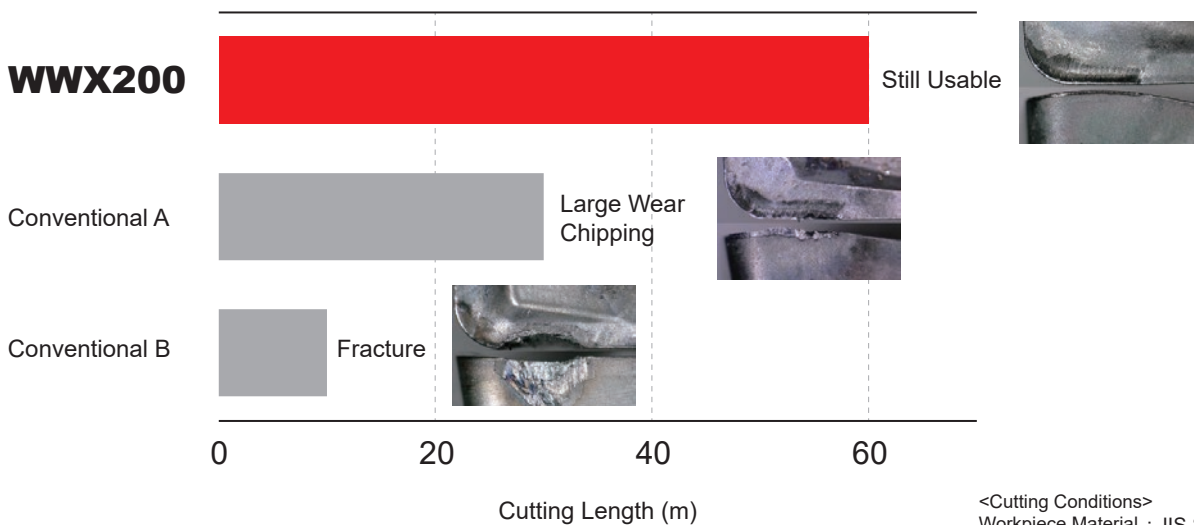

<Cutting Conditions>  
 Workpiece Material : JIS SCM440  
 Cutter Dia. : DC=φ50 mm  
 Inserts : M Breaker, MP6120  
 Cutting Speed : vc = 180 m/min  
 Feed per Tooth : fz = 0.15 mm/t.  
 Depth of Cut : ap = 2.0 mm  
 Width of Cut : ae = 40 mm  
 Cutting Mode : Dry Cutting  
 Single Insert

# Double Sided Insert Type Shoulder Mill

## SHOULDER MILLING

<GENERAL CUTTING>



# WWX200

- P
- M
- K
- N
- S
- H



Fig.1

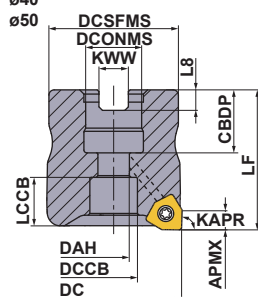
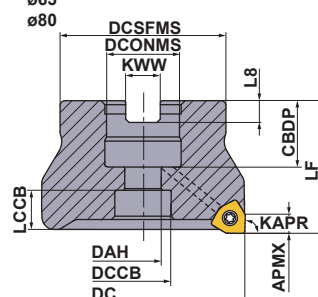

Fig.2



Right hand tool holder only.

### Arbor Type

DCON=inch size

(mm)

DC	Order Number	Stock	Coolant Hole	* No.T	LF	DCONMS	WT (kg)	APMX	RPMX (min <sup>-1</sup> )	Fig.
		R								
80	WWX200R08005CA	●	○	5	50	25.4	1.1	5.0	13600	2
80	WWX200R08007CA	●	○	7	50	25.4	1.1	5.0	13600	2
80	WWX200R08009CA	●	○	9	50	25.4	1.0	5.0	13600	2
100	WWX200R10006DA	●	○	6	50	31.75	1.6	5.0	11700	3
100	WWX200R10008DA	●	○	8	50	31.75	1.5	5.0	11700	3
100	WWX200R10011DA	●	○	11	50	31.75	1.5	5.0	11700	3
125	WWX200R12507EA	●	○	7	63	38.1	2.8	5.0	10100	3
125	WWX200R12511EA	●	○	11	63	38.1	2.8	5.0	10100	3
125	WWX200R12514EA	●	○	14	63	38.1	2.8	5.0	10100	3
160	WWX200R16009FA	●	○	9	63	50.8	4.6	5.0	8600	3
160	WWX200R16012FA	●	○	12	63	50.8	4.5	5.0	8600	3
160	WWX200R16016FA	●	○	16	63	50.8	4.5	5.0	8600	3

Note1) A set bolt to the arbor is not supplied with the body. Please refer to page 15, when ordering.

Note2) Please use a set bolt of the FMA type on the cutter body from 80 to 160 in diameter(DC).

\* Number of Teeth

● : Inventory maintained in Japan.

Fig.3

ø100  
ø125  
ø160

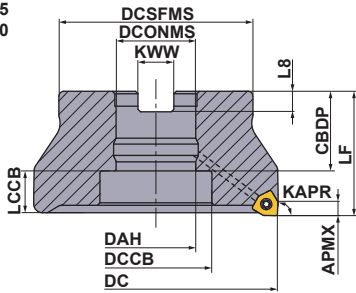
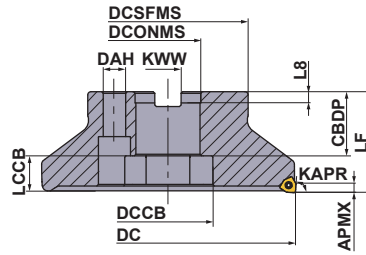

Fig.4

ø160



Right hand tool holder only.

## Arbor Type

DCON=mm size

(mm)

DC	Order Number	Stock	Coolant Hole	* No.T	LF	DCONMS	WT (kg)	APMX	RPMX (min <sup>-1</sup> )	Fig.
		R								
40	WWX200-040A03AR	●	○	3	40	16	0.2	5.0	21600	1
40	WWX200-040A04AR	●	○	4	40	16	0.2	5.0	21600	1
50	WWX200-050A04AR	●	○	4	40	22	0.4	5.0	18600	1
50	WWX200-050A05AR	●	○	5	40	22	0.4	5.0	18600	1
50	WWX200-050A06AR	●	○	6	40	22	0.3	5.0	18600	1
63	WWX200-063A05AR	●	○	5	40	22	0.5	5.0	16000	2
63	WWX200-063A06AR	●	○	6	40	22	0.5	5.0	16000	2
63	WWX200-063A07AR	●	○	7	40	22	0.5	5.0	16000	2
80	WWX200-080A05AR	●	○	5	50	27	1.1	5.0	13600	2
80	WWX200-080A07AR	●	○	7	50	27	1.0	5.0	13600	2
80	WWX200-080A09AR	●	○	9	50	27	1.0	5.0	13600	2
100	WWX200-100B06AR	●	○	6	50	32	1.7	5.0	11700	3
100	WWX200-100B08AR	●	○	8	50	32	1.7	5.0	11700	3
100	WWX200-100B11AR	●	○	11	50	32	1.7	5.0	11700	3
125	WWX200-125B07AR	●	○	7	63	40	3.1	5.0	10100	3
125	WWX200-125B11AR	●	○	11	63	40	3.0	5.0	10100	3
125	WWX200-125B14AR	●	○	14	63	40	3.0	5.0	10100	3
160	WWX200-160C09NR	●	—	9	63	40	4.6	5.0	8600	4
160	WWX200-160C12NR	●	—	12	63	40	4.6	5.0	8600	4
160	WWX200-160C16NR	●	—	16	63	40	4.6	5.0	8600	4



Note1) A set bolt to the arbor is not supplied with the body. Please refer to page 15, when ordering.

Note2) Please use a set bolt of the FMC type on the cutter body from 40 to 100 in diameter(DC).

Note3) Please use a set bolt of the FMA type on the cutter body from 125 to 160 in diameter(DC).

\* Number of Teeth

## Spare Parts

Tool Holder Type	*		
			
WWX200	Clamp Screw TPS3R	Wrench (Insert) TIP10D	Anti-seize Lubricant MK1KS

\* Clamp Torque (N · m) : TPS3R = 2.0

# Double Sided Insert Type Shoulder Mill

# WWX200

## Mounting Dimensions

(mm)

DC	Order Number	DCONMS	CBDP	DAH	DCCB	LCCB	DCSFMS	KWW	L8	Fig.
40	WWX200-040A03AR	16	18	9	13.6	13.8	37	8.4	5.6	1
40	WWX200-040A04AR	16	18	9	13.6	13.8	37	8.4	5.6	1
50	WWX200-050A04AR	22	20	11	17	11.8	47	10.4	6.3	1
50	WWX200-050A05AR	22	20	11	17	11.8	47	10.4	6.3	1
50	WWX200-050A06AR	22	20	11	17	11.8	47	10.4	6.3	1
63	WWX200-063A05AR	22	20	11	17	11.8	50	10.4	6.3	2
63	WWX200-063A06AR	22	20	11	17	11.8	50	10.4	6.3	2
63	WWX200-063A07AR	22	20	11	17	11.8	50	10.4	6.3	2
80	WWX200R08005CA	25.4	26	13	20	11.8	56	9.5	6	2
80	WWX200R08007CA	25.4	26	13	20	11.8	56	9.5	6	2
80	WWX200R08009CA	25.4	26	13	20	11.8	56	9.5	6	2
80	WWX200-080A05AR	27	23	13	20	11.8	56	12.4	7	2
80	WWX200-080A07AR	27	23	13	20	11.8	56	12.4	7	2
80	WWX200-080A09AR	27	23	13	20	11.8	56	12.4	7	2
100	WWX200R10006DA	31.75	37	31.75	45	16.8	70	12.7	8	3
100	WWX200R10008DA	31.75	37	31.75	45	16.8	70	12.7	8	3
100	WWX200R10011DA	31.75	37	31.75	45	16.8	70	12.7	8	3
100	WWX200-100B06AR	32	26	32	45	16.8	78	14.4	8	3
100	WWX200-100B08AR	32	26	32	45	16.8	78	14.4	8	3
100	WWX200-100B11AR	32	26	32	45	16.8	78	14.4	8	3
125	WWX200R12507EA	38.1	42	38.1	56	21.8	80	15.9	10	3
125	WWX200R12511EA	38.1	42	38.1	56	21.8	80	15.9	10	3
125	WWX200R12514EA	38.1	42	38.1	56	21.8	80	15.9	10	3
125	WWX200-125B07AR	40	35	42	56	21.8	89	16.4	9	3
125	WWX200-125B11AR	40	35	42	56	21.8	89	16.4	9	3
125	WWX200-125B14AR	40	35	42	56	21.8	89	16.4	9	3
160	WWX200-160C09NR	40	40	—	56	21.8	100	16.4	9	4
160	WWX200-160C12NR	40	40	—	56	21.8	100	16.4	9	4
160	WWX200-160C16NR	40	40	—	56	21.8	100	16.4	9	4
160	WWX200R16009FA	50.8	45	50.8	72	21.8	100	19.1	11	3
160	WWX200R16012FA	50.8	45	50.8	72	21.8	100	19.1	11	3
160	WWX200R16016FA	50.8	45	50.8	72	21.8	100	19.1	11	3

## Parts Sold Separately Set Bolt

(mm)

Tool Holder Type	Set Bolt		Fig.	Reference Dimensions							Geometry
	With Coolant Hole	Without Coolant Hole		a	b	c	d	e	f	g	
	Order Number	Order Number									
WWX200R080○○CA	HSC12035H	HSC12035	1	18	M12x1.75	47	12	10	—	—	Fig.1 
WWX200R100○○DA	MBA16033H	—	2	40	M16x2	43	10	14	6	23	
WWX200R125○○EA	MBA20040H	—	2	50	M20x2.5	54	14	17	6	27	
WWX200R160○○FA	MBA24045H	—	2	65	M24x3	59	14	17	10	37	
WWX200-040A○○AR	HSC08025H	—	1	13	M8x1.25	33	8	5	—	—	Fig.2 
WWX200-050A○○AR	HSC10030H	HSC10035	1	16	M10x1.5	40(45)	10	6	—	—	
WWX200-063A○○AR	HSC10030H	HSC10035	1	16	M10x1.5	40(45)	10	6	—	—	
WWX200-080A○○AR	HSC12035H	HSC12035	1	18	M12x1.75	47	12	10	—	—	
WWX200-100B○○AR	MBA16033H	—	2	40	M16x2	43	10	14	6	23	
WWX200-125B○○AR	MBA20040H	—	2	50	M20x2.5	54	14	17	6	27	
WWX200-160C○○NR	No Coolant Hole	—	2	50	M20x2.5	54	14	17	6	27	

Note 1) Please purchase the appropriate set bolt after confirming the reference dimensions. The items with an order number listed under the Set Bolt columns are also sold by MITSUBISHI MATERIALS.

Note 2) Internal coolant is necessary with the set bolt.





Fig.1

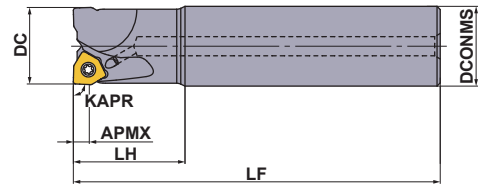
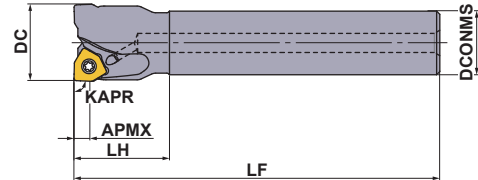

Fig.2



Right hand tool holder only.

## Shank Type



With Coolant Hole

(mm)

DC	Order Number	Stock	* No.T	LF	DCONMS	LH	WT (kg)	APMX	RPMX (min <sup>-1</sup> )	Fig.
		R								
25	WWX200R2502SA20S	●	2	115	20	30	0.3	5	29600	2
25	WWX200R2502SA25S	●	2	115	25	35	0.4	5	29600	1
25	WWX200R2502SA25L	●	2	170	25	70	0.6	5	29600	1
28	WWX200R2802SA25S	●	2	115	25	35	0.4	5	27400	2
28	WWX200R2802SA25L	●	2	170	25	35	0.6	5	27400	2
30	WWX200R3002SA25S	●	2	125	25	35	0.5	5	26200	2
32	WWX200R3202SA32S	●	2	125	32	45	0.7	5	26200	1
32	WWX200R3203SA32S	●	3	125	32	45	0.7	5	26200	1
32	WWX200R3203SA32L	●	3	190	32	90	1.0	5	26200	1
35	WWX200R3503SA32L	●	3	190	32	45	1.1	5	25100	2
40	WWX200R4003SA32S	●	3	125	32	45	0.8	5	21600	2
40	WWX200R4004SA32S	●	4	125	32	45	0.8	5	21600	2
50	WWX200R5004SA32S	●	4	125	32	45	0.9	5	18600	2
50	WWX200R5005SA32S	●	5	125	32	45	0.9	5	18600	2
50	WWX200R5006SA32S	●	6	125	32	45	0.9	5	18600	2

\* Number of Teeth

## Spare Parts

Tool Holder Type	*		
			
WWX200	Clamp Screw TPS3R	Wrench (Insert) TIP10D	Anti-seize Lubricant MK1KS

\* Clamp Torque (N · m) : TPS3R = 2.0

● : Inventory maintained in Japan.

# Double Sided Insert Type Shoulder Mill

# WWX200

## Inserts

(mm)

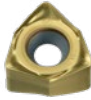
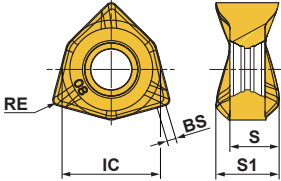
Workpiece Material	P	Steel	◆		◆	◆					◆				This is the selection guideline for WWX200. Please note that the cutting conditions differ depending on multiple factors, for more details refer to the Recommended Cutting Conditions.  <b>Edge Preparation :</b> E : Round F : Sharp				
	M	Stainless Steel	◆				◆				◆								
	K	Cast Iron	◆	◆								◆							
N	Non-ferrous Metals												◆						
S	Heat Resistant Alloys, Titanium Alloys							◆	◆										
H	Hardened Steel									◆									
Shape	Order Number	Class	Edge Preparation	Coated								Carbide		IC	S	S1	BS	RE	Geometry
				MV1020	MC5020	MP6120	MP6130	MP7130	MP9120	MP9130	VP15TF	TF15							
	<b>NEW</b> 6NGU0906040PNFR-L	G	F									●		9.0	5.3	6.1	1.6	0.4	
	6NGU0906080PNFR-L	G	F									●		9.0	5.3	6.1	1.2	0.8	
	6NMU0906040PNER-M	M	E	●	●	●	●	●	●	●	●			9.0	5.3	6.1	1.6	0.4	
	6NMU0906080PNER-M	M	E	●	●	●	●	●	●	●	●			9.0	5.3	6.1	1.2	0.8	
	6NMU0906080PNER-R	M	E	●	●	●	●	●	●	●	●			9.0	5.3	6.1	1.2	0.8	

● = NEW

# SHOULDER MILLING

<GENERAL CUTTING>



## WWX400

P M K N S H

ø50



Fig.1  
ø50

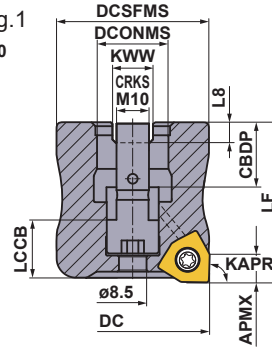
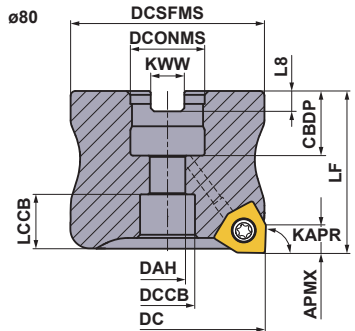

Fig.2  
ø80



Right hand tool holder only.

### Arbor Type

DCON=inch size

(mm)

DC	Order Number	Stock	Coolant Hole	* No.T	LF	DCONMS	WT (kg)	APMX	RMPX	RPMX (min <sup>-1</sup> )	Fig.
		R									
80	WWX400R08004CA	●	○	4	50	25.4	1.0	8.2	0.16°	12200	2
80	WWX400R08005CA	●	○	5	50	25.4	1.0	8.2	0.16°	12200	2
80	WWX400R08007CA	●	○	7	50	25.4	0.9	8.2	0.16°	12200	2
100	WWX400R10005DA	●	○	5	50	31.75	1.4	8.2	—	10700	3
100	WWX400R10007DA	●	○	7	50	31.75	1.4	8.2	—	10700	3
100	WWX400R10009DA	●	○	9	50	31.75	1.3	8.2	—	10700	3
125	WWX400R12506EA	●	○	6	63	38.1	2.8	8.2	—	9500	3
125	WWX400R12508EA	●	○	8	63	38.1	2.8	8.2	—	9500	3
125	WWX400R12512EA	●	○	12	63	38.1	2.7	8.2	—	9500	3
160	WWX400R16008FA	●	○	8	63	50.8	4.5	8.2	—	8300	3
160	WWX400R16010FA	●	○	10	63	50.8	4.4	8.2	—	8300	3
160	WWX400R16014FA	●	○	14	63	50.8	4.3	8.2	—	8300	3
200	WWX400R20010KN	●	—	10	63	47.625	8.1	8.2	—	7300	5
200	WWX400R20012KN	●	—	12	63	47.625	8.1	8.2	—	7300	5
200	WWX400R20016KN	●	—	16	63	47.625	8.0	8.2	—	7300	5
250	WWX400R25012KN	●	—	12	63	47.625	12.1	8.2	—	6400	5
250	WWX400R25014KN	●	—	14	63	47.625	12.1	8.2	—	6400	5
250	WWX400R25018KN	●	—	18	63	47.625	12.0	8.2	—	6400	5

Note1) A set bolt to the arbor is not supplied with the body. Please refer to page 20, when ordering.

Note2) Please use a set bolt of the FMA type on the cutter body from 80 to 250 in diameter(DC).

\* Number of Teeth

# Double Sided Insert Type Shoulder Mill

## WWX400

Fig.3

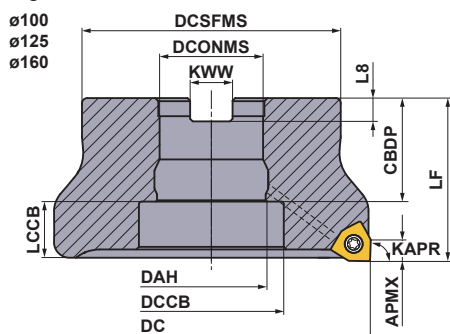

Fig.4

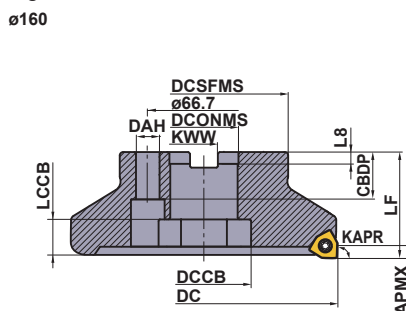
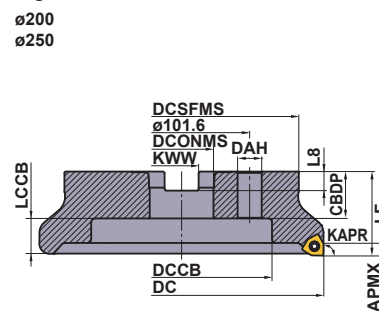

Fig.5



Right hand tool holder only.

### Arbor Type

DCON = mm size

(mm)

DC	Order Number	Stock	Coolant Hole	* No.T	LF	DCONMS	WT (kg)	APMX	RMPX	RPMX (min <sup>-1</sup> )	Fig.
		R									
50	WWX400-050A03AR	●	○	3	55	22	0.5	8.2	0.4°	5000	1
50	WWX400-050A04AR	●	○	4	55	22	0.5	8.2	0.4°	5000	1
63	WWX400-063A03AR	●	○	3	40	22	0.5	8.2	0.26°	14100	2
63	WWX400-063A04AR	●	○	4	40	22	0.5	8.2	0.26°	14100	2
63	WWX400-063A05AR	●	○	5	40	22	0.5	8.2	0.26°	14100	2
80	WWX400-080A04AR	●	○	4	50	27	1.0	8.2	0.16°	12200	2
80	WWX400-080A05AR	●	○	5	50	27	1.0	8.2	0.16°	12200	2
80	WWX400-080A07AR	●	○	7	50	27	0.9	8.2	0.16°	12200	2
100	WWX400-100B05AR	●	○	5	50	32	1.6	8.2	—	10700	3
100	WWX400-100B07AR	●	○	7	50	32	1.5	8.2	—	10700	3
100	WWX400-100B09AR	●	○	9	50	32	1.5	8.2	—	10700	3
125	WWX400-125B06AR	●	○	6	63	40	3.0	8.2	—	9500	3
125	WWX400-125B08AR	●	○	8	63	40	3.0	8.2	—	9500	3
125	WWX400-125B12AR	●	○	12	63	40	2.9	8.2	—	9500	3
160	WWX400-160C08NR	●	—	8	63	40	4.5	8.2	—	8300	4
160	WWX400-160C10NR	●	—	10	63	40	4.4	8.2	—	8300	4
160	WWX400-160C14NR	●	—	14	63	40	4.4	8.2	—	8300	4
200	WWX400-200C10NR	●	—	10	63	60	6.7	8.2	—	7300	5
200	WWX400-200C12NR	●	—	12	63	60	6.7	8.2	—	7300	5
200	WWX400-200C16NR	●	—	16	63	60	6.6	8.2	—	7300	5
250	WWX400-250C12NR	●	—	12	63	60	11.5	8.2	—	6400	5
250	WWX400-250C14NR	●	—	14	63	60	11.5	8.2	—	6400	5
250	WWX400-250C18NR	●	—	18	63	60	11.4	8.2	—	6400	5

Note1) A set bolt to the arbor is not supplied with the body. Please refer to page 20, when ordering.

Note2) The milling cutter with cutting diameter DC=50 mm has a built-in set bolt. The set bolt cannot be replaced.



Therefore, do not disassemble the milling cutter.

Note3) Please use a set bolt of the FMC type on the cutter body from 63 to 100 in diameter(DC).

Note4) Please use a set bolt of the FMA type on the cutter body from 125 to 250 in diameter(DC).

\* Number of Teeth

### Spare Parts

Tool Holder Type	*		
			
WWX400	Clamp Screw TS5R	Wrench (Insert) TKY20T	Anti-seize Lubricant MK1KS

\* Clamp Torque (N · m) : TS5R = 5.0

● : Inventory maintained in Japan.

## Mounting Dimensions

(mm)

DC	Order Number	DCONMS	CBDP	DAH	DCCB	LCCB	DCSFMS	KWW	L8	Fig.
50	WWX400-050A03AR	22	20	—	—	12.2	47	10.4	6.3	1
50	WWX400-050A04AR	22	20	—	—	12.2	47	10.4	6.3	1
63	WWX400-063A03AR	22	20	11	17	11.2	50	10.4	6.3	2
63	WWX400-063A04AR	22	20	11	17	11.2	50	10.4	6.3	2
63	WWX400-063A05AR	22	20	11	17	11.2	50	10.4	6.3	2
80	WWX400R08004CA	25.4	26	13	20	14.2	56	9.5	6	2
80	WWX400R08005CA	25.4	26	13	20	14.2	56	9.5	6	2
80	WWX400R08007CA	25.4	26	13	20	14.2	56	9.5	6	2
80	WWX400-080A04AR	27	23	13	20	14.2	56	12.4	7	2
80	WWX400-080A05AR	27	23	13	20	14.2	56	12.4	7	2
80	WWX400-080A07AR	27	23	13	20	14.2	56	12.4	7	2
100	WWX400R10005DA	31.75	37	31.75	45	11.2	70	12.7	8	3
100	WWX400R10007DA	31.75	37	31.75	45	11.2	70	12.7	8	3
100	WWX400R10009DA	31.75	37	31.75	45	11.2	70	12.7	8	3
100	WWX400-100B05AR	32	32	32	45	16.2	78	14.4	8	3
100	WWX400-100B07AR	32	32	32	45	16.2	78	14.4	8	3
100	WWX400-100B09AR	32	32	32	45	16.2	78	14.4	8	3
125	WWX400R12506EA	38.1	42	38.1	56	19.2	80	15.9	10	3
125	WWX400R12508EA	38.1	42	38.1	56	19.2	80	15.9	10	3
125	WWX400R12512EA	38.1	42	38.1	56	19.2	80	15.9	10	3
125	WWX400-125B06AR	40	40	40	56	21.2	89	16.4	9	3
125	WWX400-125B08AR	40	40	40	56	21.2	89	16.4	9	3
125	WWX400-125B12AR	40	40	40	56	21.2	89	16.4	9	3
160	WWX400-160C08NR	40	40	14	56	21.2	100	16.4	9	4
160	WWX400-160C10NR	40	40	14	56	21.2	100	16.4	9	4
160	WWX400-160C14NR	40	40	14	56	21.2	100	16.4	9	4
160	WWX400R16008FA	50.8	45	50.8	72	16.2	100	19.1	11	3
160	WWX400R16010FA	50.8	45	50.8	72	16.2	100	19.1	11	3
160	WWX400R16014FA	50.8	45	50.8	72	16.2	100	19.1	11	3
200	WWX400R20010KN	47.625	35	18	135	26.2	175	25.4	14.22	5
200	WWX400R20012KN	47.625	35	18	135	26.2	175	25.4	14.22	5
200	WWX400R20016KN	47.625	35	18	135	26.2	175	25.4	14.22	5
200	WWX400-200C10NR	60	32	18	135	29.2	160	25.7	14.22	5
200	WWX400-200C12NR	60	32	18	135	29.2	160	25.7	14.22	5
200	WWX400-200C16NR	60	32	18	135	29.2	160	25.7	14.22	5
250	WWX400R25012KN	47.625	35	18	180	26.2	210	25.4	14.22	5
250	WWX400R25014KN	47.625	35	18	180	26.2	210	25.4	14.22	5
250	WWX400R25018KN	47.625	35	18	180	26.2	210	25.4	14.22	5
250	WWX400-250C12NR	60	32	18	180	29.2	210	25.7	14.22	5
250	WWX400-250C14NR	60	32	18	180	29.2	210	25.7	14.22	5
250	WWX400-250C18NR	60	32	18	180	29.2	210	25.7	14.22	5

## Parts Sold Separately Set Bolt

(mm)

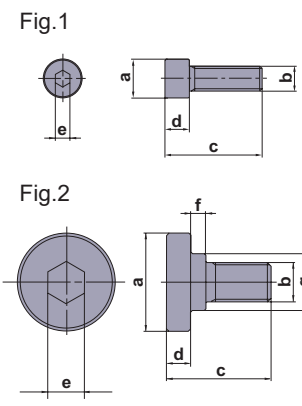
Tool Holder Type	Set Bolt		Fig.	Reference Dimensions							Geometry
	With Coolant Hole	Without Coolant Hole		a	b	c	d	e	f	g	
	Order Number	Order Number									
WWX400R080 $\odot\odot$ CA	HSC12035H	HSC12035	1	18	M12×1.75	47	12	10	—	—	Fig.1 
WWX400R100 $\odot\odot$ DA	MBA16033H	—	2	40	M16×2	43	10	14	6	23	
WWX400R125 $\odot\odot$ EA	MBA20040H	—	2	50	M20×2.5	54	14	17	6	27	Fig.2
WWX400R160 $\odot\odot$ FA	MBA24045H	—	2	65	M24×3	59	14	17	10	37	
WWX400R200 $\odot\odot$ KN	No Coolant Hole	—	1	24	M16×2	43	16	14	—	—	Fig.2
WWX400R250 $\odot\odot$ KN	No Coolant Hole	—	1	24	M16×2	43	16	14	—	—	
WWX400-063A $\odot\odot$ AR	HSC10030H	HSC10035	1	16	M10×1.5	40	10	6	—	—	Fig.2
WWX400-080A $\odot\odot$ AR	HSC12035H	HSC12035	1	18	M12×1.75	47	12	10	—	—	
WWX400-100B $\odot\odot$ AR	MBA16033H	—	2	40	M16×2	43	10	14	6	23	Fig.2
WWX400-125B $\odot\odot$ AR	MBA20040H	—	2	50	M20×2.5	54	14	17	6	27	
WWX400-160C $\odot\odot$ NR	No Coolant Hole	—	2	50	M20×2.5	54	14	17	6	27	Fig.2
WWX400-200C $\odot\odot$ NR	No Coolant Hole	—	1	24	M16×2	43	16	14	—	—	
WWX400-250C $\odot\odot$ NR	No Coolant Hole	—	1	24	M16×2	43	16	14	—	—	Fig.2

Note 1) Please purchase the appropriate set bolt after confirming the reference dimensions. The items with an order number listed under the Set Bolt columns are also sold by MITSUBISHI MATERIALS.

Note 2) Internal coolant is necessary with the set bolt.

Note 3) The milling cutter with cutting diameter DC=50 mm has a built-in set bolt.

Please use a 7 mm Allen wrench to tighten/loosen the set bolt.

# WWX400

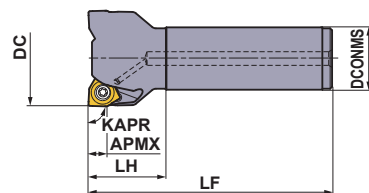

Right hand tool holder only.

## Shank Type



With Coolant Hole

(mm)

DC	Order Number	Stock	* No.T	LF	DCONMS	LH	WT (kg)	APMX	RMPX	RPMX (min <sup>-1</sup> )
		R								
50	WWX400R5003SA32M	●	3	125	32	40	0.8	8.2	0.4°	16000
50	WWX400R5004SA32M	●	4	125	32	40	0.8	8.2	0.4°	16000
63	WWX400R6303SA32M	●	3	125	32	40	1.0	8.2	0.26°	14100
63	WWX400R6304SA32M	●	4	125	32	40	1.0	8.2	0.26°	14100
63	WWX400R6305SA32M	●	5	125	32	40	1.0	8.2	0.26°	14100
80	WWX400R8004SA32M	●	4	125	32	40	1.3	8.2	0.16°	12200
80	WWX400R8005SA32M	●	5	125	32	40	1.3	8.2	0.16°	12200
80	WWX400R8007SA32M	●	7	125	32	40	1.2	8.2	0.16°	12200

\* Number of Teeth



## Spare Parts

Tool Holder Type	*		
			
<b>WWX400</b>	Clamp Screw TS5R	Wrench (Insert) TKY20T	Anti-seize Lubricant MK1KS

\* Clamp Torque (N · m) : TS5R = 5.0

## Inserts

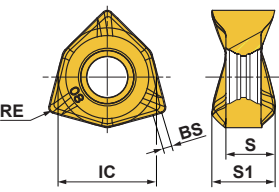
(mm)

Workpiece Material	P	Steel	◆	◆	◆	◆	◆	◆	◆	◆	◆	◆	◆	◆	◆	◆	◆	◆	◆	This is the selection guideline for WWX400. Please note that the cutting conditions differ depending on multiple factors, for more details refer to the Recommended Cutting Conditions. <b>Edge Preparation :</b> E : Round F : Sharp							
	M	Stainless Steel	◆	◆	◆	◆	◆	◆	◆	◆	◆	◆	◆	◆	◆	◆	◆	◆	◆								
	K	Cast Iron	◆	◆	◆	◆	◆	◆	◆	◆	◆	◆	◆	◆	◆	◆	◆	◆	◆								
N	Non-ferrous Metals																		◆								
S	Heat Resistant Alloys, Titanium Alloys																			◆							
H	Hardened Steel																			◆							
Shape	Order Number	Class	Edge Preparation	Coated										Carbide	IC	S	S1	BS	RE	Geometry							
				MV1020	MV1030	MC5020	MP6120	MP6130	MP7130	MP9120	MP9130	VP15TF	TF15														
	6NGU1409040PNER-L	G	E	●	●																14	7.0	9.0	1.7	0.4		
	6NGU1409080PNER-L	G	E	●	●																	14	7.0	9.0	1.3		0.8
	6NGU1409040PNFR-L	G	F											●								14	7.0	9.0	1.7		0.4
	6NGU1409080PNFR-L	G	F											●								14	7.0	9.0	1.3		0.8
	6NGU1409040PNER-M	G	E	●	●																	14	7.0	9.0	1.7		0.4
	6NGU1409080PNER-M	G	E	●	●																	14	7.0	9.0	1.3		0.8
	6NMU1409040PNER-M	M	E	●	●																	14	7.0	9.0	1.7		0.4
	6NMU1409080PNER-M	M	E	●	●																	14	7.0	9.0	1.3		0.8
	6NMU1409160PNER-M	M	E	●	●																	14	7.0	9.0	0.5		1.6
	6NMU1409200PNER-M	M	E	●	●																	14	7.0	9.0	0.5		2.0
	6NMU1409080PNER-R	M	E	●	●																	14	7.0	9.0	1.3		0.8
	6NMU1409160PNER-R	M	E	●	●																	14	7.0	9.0	0.5		1.6
	6NMU1409200PNER-R	M	E	●	●																	14	7.0	9.0	0.5		2.0
	 Wiper	2NGU1406ZNER6C-M	G	E		●	●															14	6.3	-	6.5		-

## Instructions for Use of Wiper Inserts

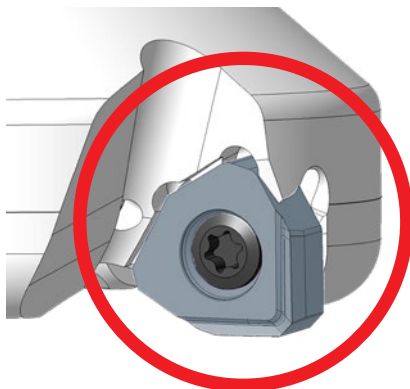

Fig.1

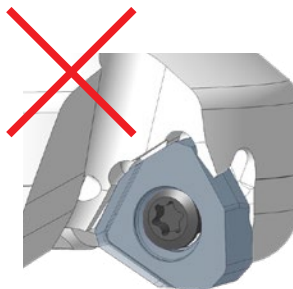

Fig.2

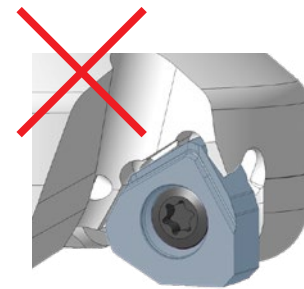

Fig.3

Wiper inserts for WWX400 are two-cornered. Please set as shown in Fig.1.

Excellent surface finishes can be achieved with one wiper.

Set more than 2 wiper inserts, equally spaced, when the feed per revolution is larger than 6.5mm/rev.

When choosing a wiper insert select a general grade that is similar to the ideal cutting conditions.

# WWX200/400

## Recommended Cutting Conditions

### ■ Dry Cutting Cutting Speed

(mm)

Workpiece Material	Properties	Cutting Conditions	Grade	ae			
				0.5DC≥	0.8DC≥	DC(Slot)	
				vc (m/min)			
P	Mild Steel	●	MV1020	300(250–350)	280(230–330)	250(200–300)	
		●	MP6120	240(200–280)	220(180–260)	200(160–240)	
		●	MV1030	230(190–270)	210(170–250)	190(150–230)	
		●	MV1020	290(240–340)	260(210–320)	240(190–290)	
		●	MV1030,MP6130	230(190–270)	210(170–250)	190(150–230)	
		✱	MP6130,VP15TF	210(170–250)	190(150–230)	170(130–210)	
	Carbon Steel Alloy Steel	Hardness 180–280HB	●	MV1020	260(210–310)	240(190–280)	210(160–260)
			●	MP6120	210(170–250)	190(150–230)	170(130–210)
			●	MV1030	200(160–240)	180(140–220)	160(120–200)
			●	MV1020	250(200–300)	230(180–270)	200(150–250)
			●	MV1030,MP6130	200(160–240)	180(140–220)	160(120–200)
			✱	MP6130,VP15TF	180(140–220)	160(120–200)	140(100–180)
	Carbon Steel Alloy Steel Alloy Tool Steel	Hardness 280–350HB ≤350HB (Annealing)	●	MV1020	260(210–310)	240(190–280)	210(160–260)
			●	MP6120	200(160–240)	180(140–220)	160(120–200)
			●	MV1030	200(160–240)	180(140–220)	160(120–200)
			●	MV1020	250(200–300)	230(180–270)	200(150–250)
			●	MV1030,MP6130	190(150–230)	170(130–210)	150(110–190)
			✱	MP6130,VP15TF	170(130–210)	150(110–190)	130(90–170)
	Pre-hardened Steel	Hardness 35–45HRC	●	MP6120	140(120–160)	–	–
			●	MP6130	120(100–140)	–	–
✱			MP6130,VP15TF	110(90–130)	–	–	
M	Austenitic Stainless Steel	●	MV1030,MP7130	180(160–200)	160(140–180)	–	
		●	MV1030,MP7130,VP15TF	170(150–190)	150(130–170)	–	
		✱	MP7130,VP15TF	150(130–170)	130(110–150)	–	
	Austenitic Stainless Steel	Hardness >200HB	●	MV1030,MP7130	170(150–190)	150(130–170)	–
			●	MV1030,MP7130,VP15TF	160(140–180)	140(120–160)	–
			✱	MP7130,VP15TF	140(120–160)	120(100–140)	–
	Ferritic and Martensitic Stainless Steel	Hardness ≤200HB	●	MV1030,MP7130	180(160–200)	160(140–180)	–
			●	MV1030,MP7130,VP15TF	170(150–190)	150(130–170)	–
			✱	MP7130,VP15TF	150(130–170)	130(110–150)	–
	Duplex Stainless Steel	Hardness ≤280HB	●	MP7130	160(140–180)	140(120–160)	–
			●	MP7130,VP15TF	150(130–170)	130(110–150)	–
			✱	MP7130,VP15TF	130(110–150)	110(90–130)	–
Precipitation Hardening Stainless Steel	Hardness <450HB	●	MP7130	140(120–160)	–	–	
		●	MP7130,VP15TF	130(110–150)	–	–	
		✱	MP7130,VP15TF	110(90–130)	–	–	
K	Gray Cast Iron	●	MC5020	250(210–290)	230(190–270)	210(170–250)	
		●	MC5020	240(200–280)	220(180–260)	200(160–240)	
		●	VP15TF	240(200–280)	220(180–260)	–	
		✱	MC5020,VP15TF	220(180–260)	200(160–240)	180(140–220)	
	Ductile Cast Iron	Tensile Strength ≤450MPa	●	MV1020	240(200–310)	220(170–280)	200(150–260)
			●	MC5020	220(180–260)	200(160–240)	180(140–220)
			●	MV1030	210(170–250)	190(150–230)	170(130–210)
			●	MV1020	230(190–300)	210(160–270)	190(140–250)
			●	MV1030,MC5020	210(170–250)	190(150–230)	170(130–210)
			●	VP15TF	210(170–250)	190(150–230)	–
			✱	MC5020,VP15TF	190(150–230)	170(130–210)	150(110–190)
	Ductile Cast Iron	Tensile Strength ≤800MPa	●	MV1020	210(160–280)	190(140–250)	160(120–210)
			●	MC5020	180(140–220)	160(120–200)	140(100–180)
			●	MV1030	170(130–210)	150(110–190)	130(90–170)
			●	MV1020	200(150–270)	180(130–240)	150(110–210)
			●	MV1030,MC5020	170(130–210)	150(110–190)	130(90–170)
			●	VP15TF	170(130–210)	150(110–190)	–
			✱	MC5020,VP15TF	150(110–190)	130(90–170)	110(70–150)
H	Hardened Steel	●	VP15TF	50(30–70)	–	–	
		●	MP6120	40(30–70)	–	–	

Note 1) The recommended cutting speed has been calculated for a depth of cut 2mm. Please reduce the cutting speed by an appropriate amount corresponding to the increase in cutting depth.



**Cutting Conditions (Guide)**

● : Stable Cutting ● : General Cutting ✖ : Unstable Cutting

**Wet Cutting  
Cutting Speed**

(mm)

Workpiece Material	Properties	Cutting Conditions	Grade	ae			
				0.5DC≥	0.8DC≥	DC(Slot)	
				vc (m/min)			
P	Mild Steel	Hardness ≤180HB	●	MV1020	220(210–230)	190(180–210)	180(160–190)
			●	MP6120	150(140–160)	130(120–140)	120(110–130)
			●	MV1030	140(130–150)	120(110–130)	110(100–120)
			●	MV1020	210(200–220)	180(170–200)	170(150–180)
			●	MV1030,MP6130	140(130–150)	120(110–130)	110(100–120)
			✖	MP6130,VP15TF	120(110–130)	100(90–110)	90(80–100)
	Carbon Steel Alloy Steel	Hardness 180–280HB	●	MV1020	200(190–210)	170(160–190)	160(150–170)
			●	MP6120	150(140–160)	130(120–140)	120(110–130)
			●	MV1030	140(130–150)	120(110–130)	110(100–120)
			●	MV1020	190(180–200)	160(150–180)	150(140–160)
			●	MV1030,MP6130	140(130–150)	120(110–130)	110(100–120)
			✖	MP6130,VP15TF	120(110–130)	100(90–110)	90(80–100)
	Carbon Steel Alloy Steel Alloy Tool Steel	Hardness 280–350HB ≤350HB (Annealing)	●	MV1020	200(190–210)	170(160–190)	160(150–170)
			●	MP6120, MV1030	140(130–150)	120(110–130)	110(100–120)
			●	MV1020	190(180–200)	160(150–180)	150(140–160)
			●	MV1030	140(130–150)	120(110–130)	110(100–120)
			●	MP6130	130(120–140)	110(100–120)	100(90–110)
			✖	MP6130,VP15TF	110(100–120)	90(80–100)	80(70–90)
Pre-hardened Steel	Hardness 35–45HRC	●	MP6120	110(100–120)	–	–	
		●	MP6130	100(90–110)	–	–	
		✖	MP6130,VP15TF	80(70–90)	–	–	
M	Austenitic Stainless Steel	Hardness ≤200HB	●	MP7130	130(120–140)	110(100–120)	–
			●	MP7130,VP15TF	120(110–130)	100(90–110)	–
			✖	MP7130,VP15TF	100(90–110)	80(70–90)	–
	Austenitic Stainless Steel	Hardness >200HB	●	MP7130	130(120–140)	110(100–120)	–
			●	MP7130,VP15TF	120(110–130)	100(90–110)	–
			✖	MP7130,VP15TF	100(90–110)	80(70–90)	–
	Ferritic and Martensitic Stainless Steel	Hardness ≤200HB	●	MP7130	130(120–140)	110(100–120)	–
			●	MP7130,VP15TF	120(110–130)	100(90–110)	–
			✖	MP7130,VP15TF	100(90–110)	80(70–90)	–
	Duplex Stainless Steel	Hardness ≤280HB	●	MP7130	120(110–130)	100(90–110)	–
			●	MP7130,VP15TF	110(100–120)	90(80–100)	–
			✖	MP7130,VP15TF	90(80–100)	70(60–80)	–
Precipitation Hardening Stainless Steel	Hardness <450HB	●	MP7130	120(110–130)	–	–	
		●	MP7130,VP15TF	110(100–120)	–	–	
		✖	MP7130,VP15TF	90(80–100)	–	–	
K	Gray Cast Iron	Tensile Strength ≤350MPa	●	MC5020	170(150–190)	150(130–170)	130(110–150)
			●	MC5020	160(140–180)	140(120–160)	120(100–140)
			●	VP15TF	160(140–180)	140(120–160)	–
			✖	MC5020,VP15TF	140(120–160)	120(100–140)	100(80–120)
	Ductile Cast Iron	Tensile Strength ≤450MPa	●	MV1020	200(180–240)	180(150–220)	150(130–200)
			●	MC5020	170(150–190)	150(130–170)	130(110–150)
			●	MV1030	160(140–180)	140(120–160)	120(100–140)
			●	MV1020	190(170–230)	170(140–210)	140(120–190)
			●	MV1030,MC5020	160(140–180)	140(120–160)	120(100–140)
			●	VP15TF	160(140–180)	140(120–160)	–
			✖	MC5020,VP15TF	140(120–160)	120(100–140)	100(80–120)
	Ductile Cast Iron	Tensile Strength ≤800MPa	●	MV1020	180(170–210)	160(150–190)	140(120–160)
			●	MC5020	160(150–170)	140(130–150)	120(110–130)
			●	MV1030	150(140–160)	130(120–140)	110(100–120)
			●	MV1020	170(160–200)	150(140–180)	120(110–150)
			●	MV1030,MC5020	150(140–160)	130(120–140)	110(100–120)
			●	VP15TF	150(140–160)	130(120–140)	–
			✖	MC5020,VP15TF	130(120–140)	110(100–120)	90(80–100)

Note 1) The recommended cutting speed has been calculated for a depth of cut 2mm. Please reduce the cutting speed by an appropriate amount corresponding to the increase in cutting depth.

# WWX200/400

## Recommended Cutting Conditions

### Wet Cutting Cutting Speed

(mm)

Workpiece Material	Properties	Cutting Conditions	Grade	ae		
				0.5DC≥	0.8DC≥	DC(Slot)
				vc (m/min)		
N Aluminium Alloys	Content Si<5%	●	TF15	500(300-900)	500(300-900)	500(300-900)
		●	TF15	500(300-900)	500(300-900)	500(300-900)
		✱	TF15	400(200-800)	400(200-800)	400(200-800)
S Titanium Alloys	-	●	MP9120	80(60-100)	-	-
		●	MP9120	70(50-90)	-	-
		✱	MP9130	60(40-80)	-	-
Heat Resistant Alloys	-	●	MP9120	60(50-70)	-	-
		●	MP9120	50(30-60)	-	-
		✱	MP9130	40(20-40)	-	-
H Hardened Steel	Hardness 40-55HRC	● ●	VP15TF	50(30-70)	-	-
		●	MP6120	40(30-70)	-	-

Note 1) The recommended cutting speed has been calculated for a depth of cut 2mm. Please reduce the cutting speed by an appropriate amount corresponding to the increase in cutting depth.

# Memo

---

A series of horizontal dashed lines for writing.

# WWX200

## Recommended Cutting Conditions

### Depth of Cut / Feed per Tooth

Workpiece Material	Properties	Cutting Conditions	Cutting Mode	Grade	ae			
					0.5DC ≥			
					Breaker	ap	fz (mm/t.)	
P	Mild Steel	Hardness ≤180HB	●	Dry, Wet	MV1020,MP6120	M	≤3.0	0.13(0.10–0.15)
			●	Dry, Wet	MV1020,MP6130	M	≤3.0	0.13(0.10–0.15)
			●	Dry, Wet		M,R	≤3.0	0.16(0.10–0.20)
			⚙	Dry, Wet	MP6130,VP15TF	R	≤3.0	0.13(0.10–0.15)
	Carbon Steel Alloy Steel	Hardness 180–280HB	●	Dry, Wet	MV1020,MP6120	M	≤3.0	0.13(0.10–0.15)
			●	Dry, Wet	MV1020,MP6130	M	≤3.0	0.13(0.10–0.15)
			●	Dry, Wet		R	≤3.0	0.16(0.10–0.20)
			⚙	Dry, Wet	MP6130,VP15TF	R	≤3.0	0.13(0.10–0.15)
	Carbon Steel Alloy Steel Alloy Tool Steel	Hardness 280–350HB ≤350HB (Annealing)	●	Dry, Wet	MV1020,MP6120	M	≤3.0	0.13(0.10–0.15)
			●	Dry, Wet	MV1020,MP6130	M	≤3.0	0.13(0.10–0.15)
			●	Dry, Wet		R	≤3.0	0.16(0.10–0.20)
			⚙	Dry, Wet	MP6130,VP15TF	R	≤3.0	0.13(0.10–0.15)
Pre-hardened Steel	Hardness 35–45HRC	●	Dry, Wet	MP6120	M	≤2.0	0.13(0.10–0.15)	
		●	Dry, Wet	MP6130	M	≤2.0	0.13(0.10–0.15)	
		●	Dry, Wet		R	≤2.0	0.16(0.10–0.20)	
		⚙	Dry, Wet	MP6130,VP15TF	R	≤2.0	0.13(0.10–0.15)	
M	Austenitic Stainless Steel	Hardness ≤200HB	●	Dry, Wet	MP7130	M	≤3.0	0.13(0.10–0.15)
			●	Dry, Wet	VP15TF	M	≤3.0	0.16(0.10–0.20)
			⚙	Dry, Wet	MP7130,VP15TF	M	≤3.0	0.13(0.10–0.15)
	Austenitic Stainless Steel	Hardness >200HB	●	Dry	MP7130	M	≤2.0	0.13(0.10–0.15)
			●	Wet		M	≤3.0	0.13(0.10–0.15)
			●	Dry		M	≤2.0	0.13(0.10–0.15)
			●	Wet	VP15TF	M	≤3.0	0.13(0.10–0.15)
			●	Dry		M	≤2.0	0.16(0.10–0.20)
			●	Wet		M	≤3.0	0.16(0.10–0.20)
			⚙	Dry		MP7130,VP15TF	M	≤2.0
	⚙	Wet	M	≤3.0	0.13(0.10–0.15)			
	Ferritic and Martensitic Stainless Steel	Hardness ≤200HB	●	Dry, Wet	MP7130	M	≤3.0	0.13(0.10–0.15)
			●	Dry, Wet	VP15TF	M	≤3.0	0.16(0.10–0.20)
			⚙	Dry, Wet	MP7130,VP15TF	M	≤3.0	0.13(0.10–0.15)
	Duplex Stainless Steel	Hardness ≤280HB	●	Dry	MP7130	M	≤2.0	0.13(0.10–0.15)
			●	Wet		M	≤3.0	0.13(0.10–0.15)
			●	Dry	VP15TF	M	≤2.0	0.16(0.10–0.20)
			●	Wet		M	≤3.0	0.16(0.10–0.20)
⚙			Dry	MP7130,VP15TF	M	≤2.0	0.13(0.10–0.15)	
⚙			Wet		M	≤3.0	0.13(0.10–0.15)	
Precipitation Hardening Stainless Steel	Hardness <450HB	●	Dry, Wet	MP7130	M	≤2.0	0.13(0.10–0.15)	
		●	Dry, Wet	VP15TF	M	≤2.0	0.16(0.10–0.20)	
		⚙	Dry, Wet	MP7130,VP15TF	M	≤2.0	0.13(0.10–0.15)	
K	Gray Cast Iron	Tensile Strength ≤350MPa	●	Dry, Wet	MC5020	M	≤3.0	0.13(0.10–0.15)
			●	Dry, Wet	VP15TF	R	≤3.0	0.16(0.10–0.20)
	Ductile Cast Iron	Tensile Strength ≤800MPa	●	Dry, Wet	MV1020,MC5020	M	≤3.0	0.13(0.10–0.15)
			●	Dry, Wet	MC5020,VP15TF	R	≤3.0	0.16(0.10–0.20)
N	Aluminium Alloys	Content Si <5%	●	Wet	TF15	L	≤3.0	0.13(0.10–0.15)
S	Titanium Alloys	–	●	Wet	MP9120	M	≤2.0	0.10(0.05–0.13)
			⚙	Wet	MP9130	M	≤2.0	0.10(0.05–0.13)
	Heat Resistant Alloys	–	●	Wet	MP9120	M	≤2.0	0.10(0.05–0.13)
			⚙	Wet	MP9130	M	≤2.0	0.10(0.05–0.13)
H	Hardened Steel	Hardness 40–55HRC	●	Dry, Wet	VP15TF	M	≤2.0	0.05(0.05–0.10)
			●	Dry, Wet	VP15TF,MP6120	R	≤2.0	0.05(0.05–0.10)

Note 1) Refer to the above table and set up cutting conditions according to the application.

Cutting Conditions (Guide)

● : Stable Cutting ● : General Cutting ✖ : Unstable Cutting

(mm)

ae			ae		
0.8DC ≥			DC(Slot)		
Breaker	ap	fz (mm/t.)	Breaker	ap	fz (mm/t.)
M	≤3.0	0.13(0.10-0.15)	M	≤2.0	0.13(0.10-0.15)
M	≤3.0	0.13(0.10-0.15)	M	≤2.0	0.13(0.10-0.15)
R	≤3.0	0.16(0.10-0.20)	—	—	—
R	≤3.0	0.13(0.10-0.15)	M	≤2.0	0.13(0.10-0.15)
M	≤3.0	0.13(0.10-0.15)	M	≤2.0	0.13(0.10-0.15)
M	≤3.0	0.13(0.10-0.15)	M	≤2.0	0.13(0.10-0.15)
R	≤3.0	0.16(0.10-0.20)	—	—	—
R	≤3.0	0.13(0.10-0.15)	M	≤2.0	0.13(0.10-0.15)
M	≤3.0	0.13(0.10-0.15)	M	≤2.0	0.13(0.10-0.15)
M	≤3.0	0.13(0.10-0.15)	M	≤2.0	0.13(0.10-0.15)
R	≤3.0	0.16(0.10-0.20)	—	—	—
R	≤3.0	0.13(0.10-0.15)	M	≤2.0	0.13(0.10-0.15)
—	—	—	—	—	—
—	—	—	—	—	—
—	—	—	—	—	—
—	—	—	—	—	—
M	≤3.0	0.13(0.10-0.15)	—	—	—
M	≤3.0	0.16(0.10-0.20)	—	—	—
M	≤3.0	0.13(0.10-0.15)	—	—	—
M	≤3.0	0.13(0.10-0.15)	—	—	—
M	≤3.0	0.13(0.10-0.15)	—	—	—
M	≤3.0	0.13(0.10-0.15)	—	—	—
M	≤3.0	0.16(0.10-0.20)	—	—	—
M	≤3.0	0.16(0.10-0.20)	—	—	—
M	≤3.0	0.13(0.10-0.15)	—	—	—
M	≤3.0	0.13(0.10-0.15)	—	—	—
M	≤3.0	0.13(0.10-0.15)	—	—	—
M	≤3.0	0.16(0.10-0.20)	—	—	—
M	≤3.0	0.16(0.10-0.20)	—	—	—
M	≤3.0	0.16(0.10-0.20)	—	—	—
M	≤3.0	0.16(0.10-0.20)	—	—	—
M	≤3.0	0.13(0.10-0.15)	—	—	—
—	—	—	—	—	—
—	—	—	—	—	—
—	—	—	—	—	—
M	≤3.0	0.13(0.10-0.15)	M	≤2.0	0.13(0.10-0.15)
R	≤3.0	0.16(0.10-0.20)	—	—	—
R	≤3.0	0.13(0.10-0.15)	R	≤2.0	0.13(0.10-0.15)
M	≤3.0	0.13(0.10-0.15)	M	≤2.0	0.13(0.10-0.15)
R	≤3.0	0.16(0.10-0.20)	—	—	—
R	≤3.0	0.13(0.10-0.15)	R	≤2.0	0.13(0.10-0.15)
L	≤3.0	0.13(0.10-0.15)	L	≤2.0	0.13(0.10-0.15)
—	—	—	—	—	—
—	—	—	—	—	—
—	—	—	—	—	—
—	—	—	—	—	—
—	—	—	—	—	—
—	—	—	—	—	—

# WWX400

## Recommended Cutting Conditions

### Depth of Cut / Feed per Tooth

Workpiece Material	Properties	Cutting Conditions	Cutting Mode	Grade	ae			
					0.5DC ≥			
					Breaker	ap	fz (mm/t.)	
P	Mild Steel	Hardness ≤180HB	●	Dry, Wet	MV1020,MV1030,MP6120	L,M	≤4.0	0.13(0.10—0.15)
			●	Dry, Wet	MV1020,MV1030,MP6130	L,M	≤4.0	0.13(0.10—0.15)
			●	Dry, Wet		M,R	≤4.0	0.16(0.10—0.20)
			✱	Dry, Wet	MP6130,VP15TF	M,R	≤4.0	0.13(0.10—0.15)
	Carbon Steel Alloy Steel	Hardness 180—280HB	●	Dry, Wet	MV1020,MV1030,MP6120	L,M	≤4.0	0.13(0.10—0.15)
			●	Dry, Wet	MV1020,MV1030,MP6130	L,M	≤4.0	0.13(0.10—0.15)
			●	Dry, Wet		M,R	≤4.0	0.16(0.10—0.20)
			✱	Dry, Wet	MP6130,VP15TF	M,R	≤4.0	0.13(0.10—0.15)
	Carbon Steel Alloy Steel Alloy Tool Steel	Hardness 280—350HB ≤350HB (Annealing)	●	Dry, Wet	MV1020,MV1030,MP6120	L,M	≤3.0	0.13(0.10—0.15)
			●	Dry, Wet	MV1020,MV1030,MP6130	L,M	≤3.0	0.13(0.10—0.15)
			●	Dry, Wet		M,R	≤3.0	0.16(0.10—0.20)
			✱	Dry, Wet	MP6130,VP15TF	M,R	≤3.0	0.13(0.10—0.15)
	Pre-hardened Steel	Hardness 35—45HRC	●	Dry, Wet	MP6120	L,M	≤2.0	0.13(0.10—0.15)
			●	Dry, Wet	MP6130	L,M	≤2.0	0.13(0.10—0.15)
			●	Dry, Wet		M,R	≤2.0	0.16(0.10—0.20)
			✱	Dry, Wet	MP6130,VP15TF	M,R	≤2.0	0.13(0.10—0.15)
M	Austenitic Stainless Steel	Hardness ≤200HB	● ●	Dry, Wet	MP7130	L,M	≤4.0	0.13(0.10—0.15)
			● ●	Dry	MV1030	L,M	≤2.0	0.13(0.10—0.15)
			●	Dry, Wet	VP15TF	M	≤4.0	0.16(0.10—0.20)
			✱	Dry, Wet	MP7130,VP15TF	M	≤4.0	0.13(0.10—0.15)
	Austenitic Stainless Steel	Hardness >200HB	●	Dry, Wet	MP7130	L,M	≤4.0	0.13(0.10—0.15)
			●	Dry	MV1030	L,M	≤2.0	0.13(0.10—0.15)
			●	Dry, Wet	MP7130	L,M	≤3.0	0.13(0.10—0.15)
			●	Dry	MV1030	L,M	≤2.0	0.13(0.10—0.15)
			●	Dry, Wet	VP15TF	M	≤3.0	0.16(0.10—0.20)
			✱	Dry, Wet	MP7130,VP15TF	M	≤3.0	0.13(0.10—0.15)
	Ferritic and Martensitic Stainless Steel	Hardness ≤200HB	● ●	Dry, Wet	MP7130	L,M	≤4.0	0.13(0.10—0.15)
			● ●	Dry	MV1030	L,M	≤2.0	0.13(0.10—0.15)
			●	Dry, Wet	VP15TF	M	≤4.0	0.16(0.10—0.20)
			✱	Dry, Wet	MP7130,VP15TF	M	≤3.0	0.13(0.10—0.15)
	Duplex Stainless Steel	Hardness ≤280HB	● ●	Dry	MP7130	L,M	≤3.0	0.13(0.10—0.15)
			● ●	Wet	MP7130	L,M	≤4.0	0.13(0.10—0.15)
			●	Dry	VP15TF	M	≤3.0	0.16(0.10—0.20)
			●	Wet	VP15TF	M	≤4.0	0.16(0.10—0.20)
			✱	Dry	MP7130,VP15TF	M	≤3.0	0.13(0.10—0.15)
			✱	Wet	MP7130,VP15TF	M	≤4.0	0.13(0.10—0.15)
	Precipitation Hardening Stainless Steel	Hardness <450HB	●	Dry, Wet	MP7130	L,M	≤2.0	0.13(0.10—0.15)
			●	Dry, Wet	MP7130	L,M	≤2.0	0.13(0.10—0.15)
			●	Dry, Wet	VP15TF	M	≤2.0	0.16(0.10—0.20)
			✱	Dry, Wet	MP7130,VP15TF	M	≤2.0	0.13(0.10—0.15)
K	Gray Cast Iron	Tensile Strength ≤350MPa	● ●	Dry, Wet	MC5020	L,M	≤4.0	0.13(0.10—0.15)
			●	Dry, Wet	VP15TF	M,R	≤4.0	0.16(0.10—0.20)
			✱	Dry, Wet	MC5020,VP15TF	M,R	≤4.0	0.13(0.10—0.15)
	Ductile Cast Iron	Tensile Strength ≤800MPa	● ●	Dry, Wet	MV1020,MV1030,MC5020	L,M	≤4.0	0.13(0.10—0.15)
			●	Dry, Wet	MV1020,MV1030,VP15TF	M,R	≤4.0	0.16(0.10—0.20)
			✱	Dry, Wet	MC5020,VP15TF	M,R	≤4.0	0.13(0.10—0.15)
N	Aluminium Alloys	Content Si <5%	● ● ✱	Wet	TF15	L	≤4.0	0.13(0.10—0.15)
S	Titanium Alloys	—	● ●	Wet	MP9120	L,M	≤2.0	0.10(0.05—0.13)
			✱	Wet	MP9130	L,M	≤2.0	0.10(0.05—0.13)
	Heat Resistant Alloys	—	● ●	Wet	MP9120	L,M	≤2.0	0.10(0.05—0.13)
			✱	Wet	MP9130	L,M	≤2.0	0.10(0.05—0.13)
H	Hardened Steel	Hardness 40—55HRC	●	Dry, Wet	VP15TF	M	≤2.0	0.05(0.05—0.10)
			●	Dry, Wet	VP15TF	M,R	≤2.0	0.05(0.05—0.10)

Note 1) Refer to the above table and set up cutting conditions according to the application.

**Cutting Conditions (Guide)**

● : Stable Cutting ● : General Cutting ✖ : Unstable Cutting

(mm)

ae			ae		
0.8DC≥			DC(Slot)		
Breaker	ap	fz (mm/t.)	Breaker	ap	fz (mm/t.)
L,M	≤3.0	0.13(0.10-0.15)	L,M	≤2.0	0.13(0.10-0.15)
L,M	≤3.0	0.13(0.10-0.15)	L,M	≤2.0	0.13(0.10-0.15)
M,R	≤3.0	0.16(0.10-0.20)	—	—	—
M,R	≤3.0	0.13(0.10-0.15)	M	≤2.0	0.13(0.10-0.15)
L,M	≤3.0	0.13(0.10-0.15)	L,M	≤2.0	0.13(0.10-0.15)
L,M	≤3.0	0.13(0.10-0.15)	L,M	≤2.0	0.13(0.10-0.15)
M,R	≤3.0	0.16(0.10-0.20)	—	—	—
M,R	≤3.0	0.13(0.10-0.15)	M	≤2.0	0.13(0.10-0.15)
L,M	≤3.0	0.13(0.10-0.15)	L,M	≤2.0	0.13(0.10-0.15)
L,M	≤3.0	0.13(0.10-0.15)	L,M	≤2.0	0.13(0.10-0.15)
M,R	≤3.0	0.16(0.10-0.20)	—	—	—
M,R	≤3.0	0.13(0.10-0.15)	M	≤2.0	0.13(0.10-0.15)
—	—	—	—	—	—
—	—	—	—	—	—
—	—	—	—	—	—
—	—	—	—	—	—
L,M	≤3.0	0.13(0.10-0.15)	—	—	—
L,M	≤2.0	0.13(0.10-0.15)	—	—	—
M	≤3.0	0.16(0.10-0.20)	—	—	—
M	≤3.0	0.13(0.10-0.15)	—	—	—
L,M	≤3.0	0.13(0.10-0.15)	—	—	—
L,M	≤2.0	0.13(0.10-0.15)	—	—	—
L,M	≤3.0	0.13(0.10-0.15)	—	—	—
L,M	≤2.0	0.13(0.10-0.15)	—	—	—
M	≤3.0	0.16(0.10-0.20)	—	—	—
M	≤3.0	0.13(0.10-0.15)	—	—	—
L,M	≤3.0	0.13(0.10-0.15)	—	—	—
L,M	≤2.0	0.13(0.10-0.15)	—	—	—
M	≤3.0	0.16(0.10-0.20)	—	—	—
M	≤3.0	0.13(0.10-0.15)	—	—	—
L,M	≤3.0	0.13(0.10-0.15)	—	—	—
L,M	≤3.0	0.13(0.10-0.15)	—	—	—
M	≤3.0	0.16(0.10-0.20)	—	—	—
M	≤3.0	0.16(0.10-0.20)	—	—	—
M	≤3.0	0.16(0.10-0.20)	—	—	—
M	≤3.0	0.13(0.10-0.15)	—	—	—
—	—	—	—	—	—
—	—	—	—	—	—
—	—	—	—	—	—
—	—	—	—	—	—
L,M	≤3.0	0.13(0.10-0.15)	L,M	≤2.0	0.13(0.10-0.15)
M,R	≤3.0	0.16(0.10-0.20)	—	—	—
M,R	≤3.0	0.13(0.10-0.15)	M,R	≤2.0	0.13(0.10-0.15)
L,M	≤3.0	0.13(0.10-0.15)	L,M	≤2.0	0.13(0.10-0.15)
M,R	≤3.0	0.16(0.10-0.20)	—	—	—
M,R	≤3.0	0.13(0.10-0.15)	M,R	≤2.0	0.13(0.10-0.15)
L	≤3.0	0.13(0.10-0.15)	L	≤2.0	0.13(0.10-0.15)
—	—	—	—	—	—
—	—	—	—	—	—
—	—	—	—	—	—
—	—	—	—	—	—
—	—	—	—	—	—
—	—	—	—	—	—

## WWX400

### Ramping / Helical Milling

#### ● Ramping

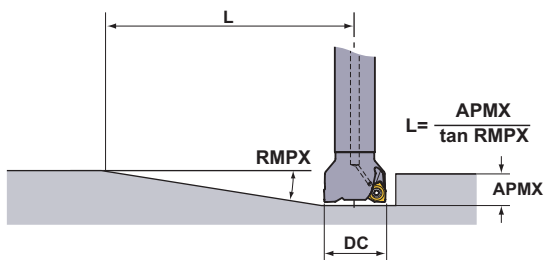

#### ● Helical Milling

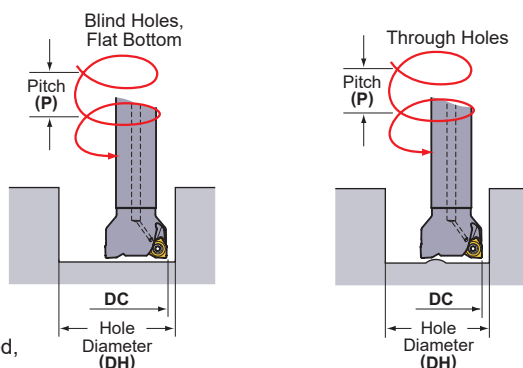

Refer to the table below for cutting conditions. For feed per tooth and cutting speed, follow the cutting conditions for slot milling.

DC	RE	APMX	Ramping		Helical Milling (Blind Hole, Flat Bottom)				Helical Milling (Through Hole)	
			RMPX	L	DH max.	P max.	DH min.	P max.	DH min.	P max.
50	0.4	8	0.40°	1175	98.5	1.06	95.2	0.99	82.5	0.7
50	0.8	8	0.40°	1175	97.7	1.05	95.2	0.99	82.5	0.7
63	0.4	8	0.26°	1807	124.5	0.88	121.2	0.83	108.6	0.6
63	0.8	8	0.26°	1807	123.7	0.87	121.2	0.83	108.6	0.6
80	0.4	8	0.16°	2936	158.5	0.69	155.2	0.66	142.6	0.5
80	0.8	8	0.16°	2936	157.7	0.68	155.3	0.66	142.6	0.5

DC = Cutting Diameter

APMX = Depth of Cut Max.

Note 1) When ramping and helical milling, it is recommended to reduce the feed per tooth.

Note 2) When ramping and helical milling, long continuous chips may be scattered so please be careful.

Note 3) WWX200 cannot be used for ramping or helical machining.

<Helical Milling>

To obtain a flat bottom surface when helical milling, it requires to remove "the uncut part" in the centre of the workpiece material at a final pass. When helical milling, make sure that the depth of cut per helical pass doesn't exceed the maximum depth of cut (APMX).

## WWX200/400

### Plunging

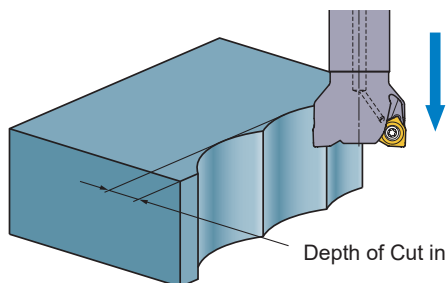

Depth of Cut in the Radial Direction : ae = WWX200 5 mm  
WWX400 8 mm



# Memo

---

A series of horizontal dashed lines for writing, spanning the width of the page.

# Memo

---

A series of horizontal dashed lines for writing, spanning the width of the page.

# Memo

---

A series of horizontal dashed lines for writing, spanning the width of the page.



Double Sided Insert Type Shoulder Mill

# WWX Series

## Environmentally Friendly Product

This product has been certified as an environmentally friendly product in the machine tool industry by the Japan Cutting & Wear-resistant Tool Association. This is a product unique to the industry, in harmony with the environment, and with the aim of fulfilling the social responsibilities of the machine tool industry.

The Japan Cutting & Wear-resistant Tool Association evaluates the product's environmental impact during the manufacturing and usage stages and issues a certification according to the evaluation score.



## WWX200, WWX400 Subject : Cutter Body and Inserts

## For People, Society and the Earth

More information about MITSUBISHI MATERIALS' efforts to address social and environmental issues can be found in the website below or by scanning the QR code.

<https://mmc.disclosure.site/en/>



### For Your Safety

●Don't handle inserts and chips without gloves. ●Please machine within the recommended application range and exchange expired tools with new ones in advance of breakage. ●Please use safety covers and wear safety glasses. ●When using compounded cutting oils, please take fire precautions. ●When attaching inserts or spare parts, please use only the correct wrench or driver. ●When using rotating tools, please make a trial run to check run-out, vibration, abnormal sounds, etc.

## MITSUBISHI MATERIALS CORPORATION

### MITSUBISHI MATERIALS CORPORATION

#### Overseas Sales Dept, Asian Region

Marunouchi Nijubashi Building 22F, 3-2-3, Marunouchi, Chiyoda-ku, Tokyo 100-8117, Japan

#### Overseas Sales Dept, European & American Region

Marunouchi Nijubashi Building 22F, 3-2-3, Marunouchi, Chiyoda-ku, Tokyo 100-8117, Japan

<http://www.mmc-carbide.com/>

(Tool specifications are subject to change without notice.)